

# NEW HIERARCHIC THEORY OF WATER AND ITS ROLE IN BIOSYSTEMS. THE QUANTUM PSI PROBLEM

ALEX KAIVARAINEN

University of Turku,  
Vesilinnantie 5, FIN-20014, Turku, Finland  
H2o@karelia.ru  
<http://www.karelia.ru/~alexk>

## CONTENTS

1. **New Hierarchic Theory of Condensed Matter and its Computerized Verification on Examples of Water & Ice**
2. **Water as a Regulating Factor of Biopolymers Properties and Evolution**
3. **Multi-Fractional Model of Interfacial Water Structure. Its Contribution to Morphogenetic Field**
4. **Hierarchic Model of Consciousness: From Molecular Bose Condensation to Synaptic Reorganization**
5. **Unified Model of Bivacuum, Matter & Fields. The Problem of Quantum Psi Phenomena**
6. **Possible Mechanism of Entanglement Between Elementary Particles, Complex Systems & Mind-Matter and Mind-Mind Interaction**

This paper contains few interrelated parts. The short version of new quantum Hierarchic theory, general for solids and liquids, created by the author is presented. Condensed matter in this theory is considered as a system of 3D standing waves (collective excitations) of different nature: thermal de Broglie waves (waves B), IR photons, related to intermolecular oscillations and thermal phonons. Theory is verified by computer simulations on examples of pure water and ice, using special computer program, yielding about 300 parameters. Theory based idea of new optoacoustic device: Comprehensive Analyzer of Matter Properties (CAMP), its various configurations and applications are presented. The full version of this paper is located at <http://arXiv.org/abs/physics/0102086>. Good correlation between simulated parameters of water and proteins dynamic structure points to crucial role of water in biopolymers evolution. It is shown, that multi-fractional model of interfacial water structure, proposed by the author, could be responsible for some of morphogenetic field properties. Computer simulations point, that coherent water clusters could be in state of mesoscopic Bose condensation (mBC). The coherent IR radiation of such clusters is responsible for exchange interaction between distant microtubules of different neurons, as a part of elementary act of consciousness proposed. Unified model of Bivacuum, corpuscule-wave duality, electromagnetic and gravitational fields has been developed. In combination with above mentioned theories it is used for possible explanation of Quantum Psi phenomena, like mind-matter interaction, telepathy, etc. (see <http://arXiv.org/abs/0207027> and <http://arXiv.org/abs/physics/0103031>). The articles, related to topics of this paper are on-line: [http://arXiv.org/find/physics/1/au:+Kaivarainen\\_A/0/1/0/all/0/1](http://arXiv.org/find/physics/1/au:+Kaivarainen_A/0/1/0/all/0/1)

## 1. New Hierarchic Theory of Condensed Matter and its Computerized Verification on Examples of Water & Ice

### 1.1 Basic notions and definitions of Hierarchic theory of matter

A quantum based new hierarchic quantitative theory, general for solids and liquids, has been developed.<sup>1-3</sup> It is assumed, that anharmonic oscillations of particles in any condensed matter lead to emergence of three-dimensional (3D) superposition of standing de Broglie waves of molecules, electromagnetic and acoustic waves. Consequently, any condensed matter could be considered as a 'gas' of 3D standing waves of corresponding nature. Our approach unifies and develops strongly the Einstein's and Debye's models and can be reduced to those after strong simplifications.

Collective excitations, like 3D standing de Broglie waves of molecules were analyzed, as a background of hierarchic model of condensed matter.

The most probable de Broglie wave (wave B) length is determined by the ratio of Plank constant to the most probable momentum of molecules, or by ratio of its most probable phase velocity to frequency. The waves B of molecules are related to their translations (*tr*) and librations (*lb*).

As the quantum dynamics of condensed matter is anharmonic and does not follow the classical Maxwell - Boltzman distribution, the real most probable de Broglie wave length can exceed the classical thermal de Broglie wave length and the distance between centers of molecules many times. *This makes possible the atomic and molecular mesoscopic Bose condensation (mBC) in solids and liquids at temperatures, below boiling point. It is one of the most important results of new theory, confirmed by computer simulations on examples of water and ice.*

**Four strongly interrelated** new types of quasiparticles (collective excitations) were introduced in our hierarchic model:

1. *Primary effectons (tr and lb)*, existing in "acoustic" (a) and "optic" (b) states represent the coherent clusters with resulting external momentum, equal to zero. *Secondary effectons* are the result of averaging of all effectons with nonzero external momentum, using Bose-Einstein distribution;
2. *Convertons*, corresponding to interconversions between *tr* and *lb* types of the effectons (flickering clusters);
3. *Primary and secondary transitons* are the intermediate [ $a \rightleftharpoons b$ ] transition states of the *tr* and *lb* primary and secondary effectons;
4. *Primary and secondary deformons* represent 3D superposition of IR electromagnetic and acoustic waves, correspondingly, activated by primary and secondary *transitons* and *convertons*.

**Primary effectons (tr and lb)** are formed by 3D superposition of the most probable standing de Broglie waves of the oscillating ions, atoms or molecules. The volume of effectons (*tr* and *lb*) may contain from less than one, to tens and even thousands of molecules. The first condition means validity of classical approximation in description of the subsystems of the effectons. The second one points to quantum properties of coherent clusters due to mesoscopic Bose condensation (mBC), in contrast to macroscopic BC, pertinent for superfluidity and superconductivity.

The liquids are semiclassical systems because their primary (*tr*) effectons contain less than one molecule and primary (*lb*) effectons - more than one molecule. The solids are quantum systems totally because both kind of their primary effectons (*tr* and *lb*) are mesoscopic molecular Bose condensates. These consequences of our theory are confirmed by computer calculations.

The 1st order [*gas* → *liquid*] transition is accompanied by strong degeneration of rotational (librational) degrees of freedom due to emergence of primary (*lb*) effectons (mBC) and

[*liquid* → *solid*] transition - by degeneration of translational degrees of freedom due to Bose-condensation of primary (tr) effectons.

In the general case the effecton can be approximated by parallelepiped with edges determined by de Broglie waves length in three selected directions (1, 2, 3), related to symmetry of molecular dynamics. In the case of isotropic molecular motion the effectons' shape is approximated by cube. The edge-length of primary effectons (tr and lb) is considered as the "parameter of order" in our theory of phase transitions.

The in-phase oscillations of molecules in the effectons correspond to the effecton's (a) - acoustic state and the counterphase oscillations correspond to their (b) - optic state. States (a) and (b) of the effectons differ in potential energy only, however, their kinetic energies, momentums and spatial dimensions - are the same. The b-state of the effectons has a common feature with Frölich's polar mode. The ( $a \rightarrow b$ ) or ( $b \rightarrow a$ ) transition states of the *primary effectons* (tr and lb), defined as *primary transitons*, are accompanied by a change in molecule polarizability and dipole moment without density fluctuation. At this case these transitions lead to absorption or radiation of IR photons, respectively. Superposition (interception) of three internal standing IR photons of different directions (1,2,3), normal to each other - forms primary electromagnetic deformons (tr and lb).

On the other hand, the [ $lb \rightleftharpoons tr$ ] *convertons* and *secondary transitons* are accompanied by the density fluctuations, leading to absorption or radiation of phonons. Superposition of three standing phonons, propagating in three directions (1,2,3), normal to each other, forms *secondary acoustic deformons (tr and lb)*.

Correlated collective excitations of primary and secondary effectons and deformons (tr and lb), localized in the volume of primary tr and lb electromagnetic deformons, lead to origination of *macroeffectons*, *macrotransitons* and *macrodeformons* (tr and lb respectively).

*Macroconvertons* are the result of simultaneous transitions [ $a_{lb} \rightleftharpoons a_{tr}$ ] and [ $b_{lb} \rightleftharpoons b_{tr}$ ] between the acoustic (a) and optic (b) modes of librational and translational effectons, accompanied by disassembly  $\rightleftharpoons$  assembly of coherent water clusters. This process is close to notion of 'flickering' clusters.

Correlated simultaneous excitations of tr and lb macroeffectons in the volume of superimposed *tr* and *lb* electromagnetic deformons lead to origination of *supereffectons*.

In turn, the simultaneous excitation of both: *tr* and *lb macrodeformons* and *macroconvertons* in the same volume means origination of *superdeformons*. Superdeformons are the biggest (cavitation) fluctuations, leading to microbubbles in liquids and to local defects in solids.

Total number of quasiparticles of condensed matter equal to  $4!=24$ , reflects all of possible combinations of the four basic ones [1-4], introduced above (Table 1). This set of collective excitations in the form of 3D standing waves of three types: thermal de Broglie waves, acoustic and electromagnetic ones - is proved to be able to explain virtually all the properties of all condensed matter.

Table 1. Schematic representation of the 18 types of quasiparticles of condensed matter as a hierarchic dynamic system, based on the effectons, transistons and deformons. Total number of *quasiparticles*, introduced in Hierarchic concept is 24. Six collective excitations, related to *convertions*- interconversions between primary librational and translational effectons and their derivatives are not represented here for the end of simplicity.

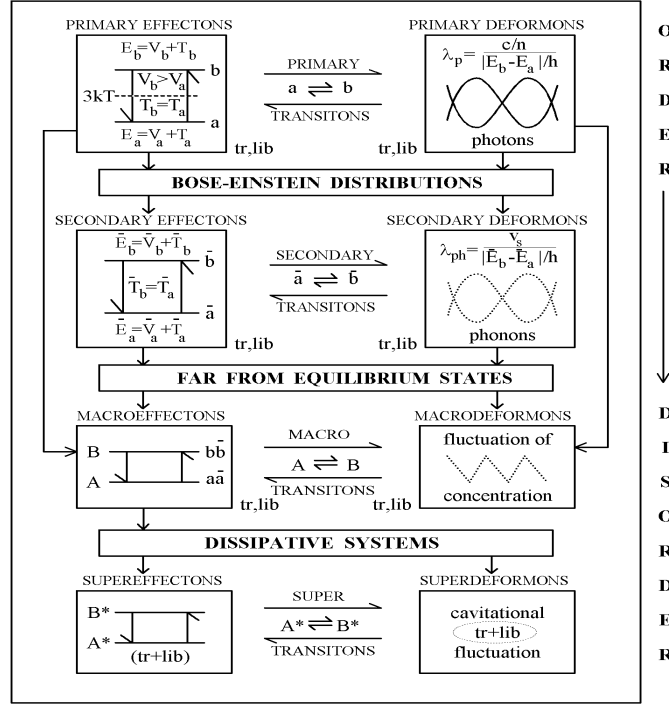

The important positive feature of our hierarchic model of matter is that it does not need the semi-empirical intermolecular potentials for calculations, which are unavoidable in existing theories of many body systems. The potential energy of intermolecular interaction is involved indirectly in dimensions and stability of quasiparticles, introduced in our model.

The main formulae of theory are the same for liquids and solids and include following experimental parameters, which take into account their different properties: [1]- Positions of (tr) and (lb) bands in oscillatory spectra; [2]- Sound velocity; [3]- Density; [4]- Refraction index.

The knowledge of these four basic parameters at the same temperature and pressure makes it possible using our computer program, to evaluate more than 300 important characteristics of any condensed matter. Among them are such as: total internal energy, kinetic and potential energies, heat-capacity and thermal conductivity, surface tension, vapor pressure, viscosity, coefficient of self-diffusion, osmotic pressure, solvent activity, etc. Most of calculated parameters are hidden, i.e. inaccessible to direct experimental measurement.

This is the first theory able to predict all known experimental temperature anomalies for water and ice. The conformity between theory and experiment is good even without adjustable parameters. The hierarchic concept creates a bridge between micro- and macro- phenomena, dynamics and thermodynamics, liquids and solids in terms of quantum physics.

## 1.2 Total Internal Energy of Condensed Matter

The final formula for the total internal energy of ( $U_{tot}$ ) of one mole of matter, leading from Hierarchic theory, considering condensed matter as a system of 3D standing waves is (see <http://arXiv.org/abs/physics/0102086>):

$$U_{tot} = V_0 \frac{1}{Z} \sum_{tr,lb} \left\{ \left[ \begin{array}{l} n_{ef} \left( P_{ef}^a E_{ef}^a + P_{ef}^b E_{ef}^b + P_t E_t \right) \\ + n_d P_d E_d \end{array} \right] + \right.$$

$$\begin{aligned}
& + \left[ \bar{n}_{ef} \left( \bar{P}_{ef}^a \bar{E}_{ef}^a + \bar{P}_{ef}^b \bar{E}_{ef}^b + \bar{P}_t \bar{E}_t \right) + \bar{n}_d \bar{P}_d \bar{E}_d \right] + \\
& + \left[ n_M \left( P_M^A E_M^A + P_M^B E_M^B \right) + n_D P_M^D E_M^D \right]_{tr,lb} + \\
& + V_0 \frac{1}{Z} \left[ n_{con} \left( P_{ac} E_{ac} + P_{bc} E_{bc} + P_{cMt} E_{cMt} \right) + \right. \\
& \left. + \left( n_{cda} P_{ac} E_{ac} + n_{cdb} P_{bc} E_{bc} + n_{cMd} P_{cMd} E_{cMd} \right) \right] + \\
& + V_0 \frac{1}{Z} n_s \left[ \left( P_S^A E_S^A + P_S^B E_S^B \right) + n_{D^*} P_S^{D^*} E_S^{D^*} \right]
\end{aligned} \tag{1.1}$$

The meaning of the variables in formulae (1), necessary for the internal energy calculations, are presented in our paper (Kaivarainen, 2001). Total potential energy of one mole of condensed matter is defined by the difference between corresponding total internal energy and total kinetic energy:  $V^{tot} = U^{tot} - T^{tot}$ .

It is important to stress, that the same equations are valid for liquids and solids in our theory.

A lot of characteristics of condensed matter, composed from 24 quasiparticles - about 300, may be calculated, using hierarchic theory and CAMP computer program [copyright 1997, Kaivarainen]. For this end we need four basic input experimental parameters at the same temperature and pressure: 1) positions of translational and librational bands in middle/far IR spectrum of condensed matter; 2) sound velocity; 3) density or molar volume; 4) refraction index.

### 1.3 *Quantitative verification of Hierarchic theory on examples of ice and water*

#### 1.3.1. *The coincidence of theoretical and experimental data for ice structure stability*

Our hierarchic theory makes it possible to calculate unprecedented big amount of parameters for liquids and solids. Part of them, accessible experimentally and taken from literature, are in good correspondence with CAMP - computer simulations.

For example, the calculated minimum of partition function for ice (Z) (Fig. 1a) corresponds to temperature of about  $-170^{\circ}\text{C}$ . For the other hand, the interval from  $-198$  to  $-173^{\circ}\text{C}$  is known, indeed, as T- anomalies one due to the fact that the heat equilibrium of ice establishes very slowly in this range (Maeno, 1988). This fact is a consequence of the less probable ice structure (minimum value of partition function Z) near  $-170^{\circ}\text{C}$ .

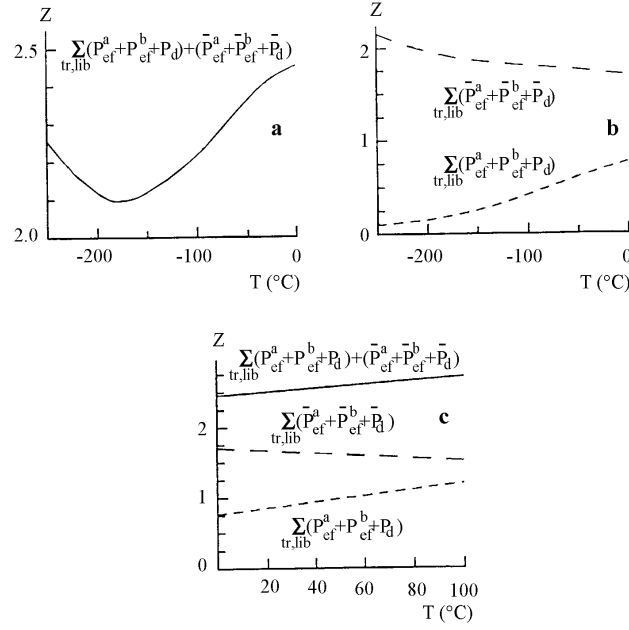

Figure 1.1 (a,b,c). Temperature dependences of the total partition function ( $Z$ ) and contributions related to primary and secondary effectons and deformons for ice (a,b) and water (c).

### 1.3.2. The coincidence of theoretical and experimental heat capacity of ice and water

It follows from Fig. 2a that the mean theoretical value of heat capacity for ice in the interval from  $-75$  to  $0^\circ\text{C}$  is equal to:

$$\bar{C}_p^{\text{ice}} = \frac{\Delta U_{\text{tot}}}{\Delta T} \approx 39 \text{ J/MK} = 9.3 \text{ cal/MK} \quad 1.2$$

For water within the whole range  $\Delta T = 100^\circ\text{C}$ , the theoretical change in the internal energy is:  $\Delta U = 17 - 9.7 = 7.3 \text{ kJ/M}$  (Fig. 2b). This corresponds to mean value of heat capacity of water:

$$C_p^{\text{water}} = \frac{\Delta U_{\text{tot}}}{\Delta T} = 73 \text{ J/MK} = 17.5 \text{ cal/MK} \quad 1.3$$

These results of calculation agree well with the experimental mean values  $C_p = 18 \text{ Cal/MK}$  for water and  $C_p = 9 \text{ cal/MK}$  for ice.<sup>4</sup>

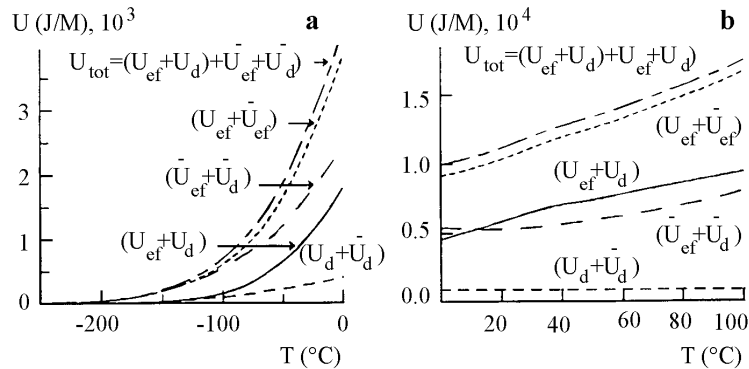

Figure. 1.2. (a,b). Temperature dependences of the total internal energy ( $U_{\text{tot}}$ ) and different contributions for ice (a) and water (b). Following contributions to  $U_{\text{tot}}$  are presented:  $(U_{\text{ef}} + \bar{U}_{\text{ef}})$  is the contribution of primary and secondary effectons;  $(U_d + \bar{U}_d)$  is the contribution of primary and secondary deformons;  $(U_{\text{ef}} + U_d)$  is the contribution of primary effectons and deformons;  $(\bar{U}_{\text{ef}} + \bar{U}_d)$  is the contribution of secondary effectons and deformons.

### 1.3.3. New State Equation for Condensed Matter

It was Van der Waals who choosed the first way more than a hundred years ago and derived the equation:

$$\left(P + \frac{a}{V^2}\right)(V - b) = RT \quad 1.4$$

where the attraction forces are accounted for by the amending term ( $a/V^2$ ), while the repulsion forces and the effects of the excluded volume accounted for the term (b).

Equation (1.4) correctly describes changes in P,V and T related to liquid-gas transitions on the qualitative level. However, the quantitative analysis of (1.4) is approximate and needs the fitting parameters. The parameters (a) and (b) are not constant for the given substance and depend on temperature. Hence, the Van der Waals equation is only some approximation describing the state of a real gas.

Using our equation for the total internal energy of condensed matter ( $U_{\text{tot}}$ ), we can present state equation in a more general form than (1.4). For this end we introduce the notions of *internal pressure* ( $P_{\text{in}}$ ), including *all type of interactions* between particles of matter and excluded molar volume ( $V_{\text{exc}}$ ):

$$V_{\text{exc}} = \frac{4}{3}\pi\alpha^*N_0 = V_0\left(\frac{n^2-1}{n^2}\right) \quad 1.5$$

where  $\alpha^*$  is the acting polarizability of molecules in condensed matter;  $N_0$  is Avogadro number, and  $V_0$  is molar volume.

The new general state equation can be expressed as:

$$P_{\text{tot}}V_{\text{fr}} = (P_{\text{ext}} + P_{\text{in}})(V_0 - V_{\text{exc}}) = U_{\text{ef}} \quad 1.6$$

where:  $U_{\text{ef}} = U_{\text{tot}}(1 + V/T_{\text{kin}}) = U_{\text{tot}}^2/T_{\text{kin}}$  is the effective internal energy and:

$$(1 + V/T_{\text{kin}}) = U_{\text{tot}}/T_{\text{kin}} = S^{-1} \quad 1.7$$

is the reciprocal value of the total structural factor;  $P_{\text{tot}} = P_{\text{ext}} + P_{\text{in}}$  is total pressure,  $P_{\text{ext}}$  and  $P_{\text{in}}$  are external and internal pressures;  $V_{\text{fr}} = V_0 - V_{\text{exc}} = V_0/n^2$  (see eq.1.5) is a free molar volume;  $U_{\text{tot}} = V + T_{\text{kin}}$  is the total internal energy,  $V$  and  $T_{\text{kin}}$  are total potential and kinetic energies of one mole of matter.

For the limit case of ideal gas, when  $P_{\text{in}} = 0$ ;  $V_{\text{exc}} = 0$ ; and the potential energy  $V = 0$ , we get from (1.6) the Clapeyrene - Mendelejev equation:

$$P_{\text{ext}}V_0 = T_{\text{kin}} = RT$$

One can use equation of state (1.6) for estimation of sum of *all types of internal matter interactions*, which determines the internal pressure  $P_{\text{in}}$ :

$$P_{\text{in}} = \frac{U_{\text{ef}}}{V_{\text{fr}}} - P_{\text{ext}} = \frac{n^2U_{\text{tot}}^2}{V_0T_{\text{kin}}} - P_{\text{ext}} \quad 1.8$$

where: the molar free volume:  $V_{\text{fr}} = V_0 - V_{\text{exc}} = V_0/n^2$ ;

and the effective total energy:  $U_{\text{ef}} = U_{\text{tot}}^2/T_{\text{kin}} = U_{\text{tot}}/S$ ; where  $S = T_{\text{kin}}/U_{\text{tot}}$  is a total structural factor.

#### 1.3.4. Coincidence between calculated and experimental vapor pressure for ice and water

There was not earlier the satisfactory quantitative theory for *vapor pressure* calculation.

Such a theory has been derived, using our notion of collective excitations: *superdeformons*, representing the biggest thermal fluctuations.<sup>2,3</sup> The basic idea is that the external equilibrium vapor pressure is related to internal one ( $P_{\text{in}}^S$ ) with coefficient determined by the probability of

cavitation fluctuations (superdeformons) in the **surface layer** of liquids or solids.

In other words due to excitation of superdeformons with probability ( $P_D^S$ ), the internal pressure ( $P_{in}^S$ ) in surface layers, determined by the total contributions of all intramolecular interactions turns to external one - vapor pressure ( $P_V$ ). It is something like a compressed spring energy realization due to trigger switching off.

For taking into account the difference between the surface and bulk internal pressure ( $P_{in}$ ) we introduce the semi-empirical surface pressure factor ( $q^S$ ) as:

$$P_{in}^S = q^S P_{in} = q^S \left( \frac{n^2 U_{tot}}{V_0 S} - P_{ext} \right) \quad 1.9$$

where:  $P_{in}$  corresponds to eq.(1.8);  $S = T_{kin}/U_{tot}$  is a total structure factor.

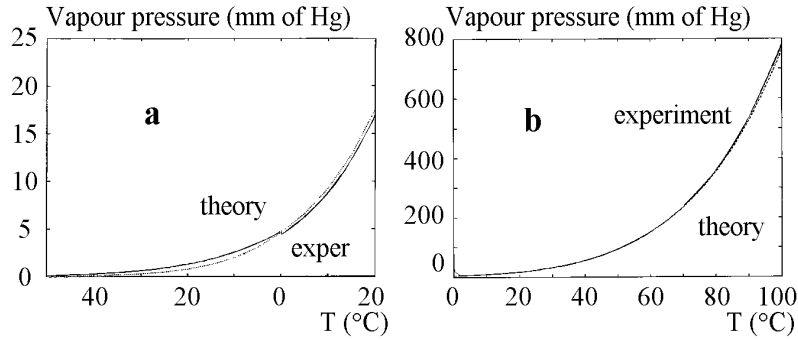

Figure. 1.3. a) Theoretical (—) and experimental (· ·) temperature dependences of vapor pressure ( $P_{vap}$ ) for ice (a) and water (b), including phase transition region. The experimental data were taken from Handbook of Chem. & Phys. 67 ed., CRC press, 1986-1987.

Multiplying (1.9) to probability of superdeformons excitation we obtain for vapor pressure, resulting from evaporation or sublimation, the following formulae:

$$P_{vap} = P_{in}^S \cdot P_D^S = q^S \left( \frac{n^2 U_{tot}^2}{V_0 T_{kin}} - P_{ext} \right) \exp \left( -\frac{E_D^S}{kT} \right) \quad 1.10$$

where:

$$P_D^S = \exp \left( -\frac{E_D^S}{kT} \right) \quad 1.11$$

is a probability of superdeformons excitation (see eqs. 3.37, 3.32 and 3.33 from<sup>3</sup>).

The pressure surface factor ( $q^S$ ) could be presented as:

$$q^S = P_{in}^S / P_{in}$$

Theoretical calculated temperature dependences of vapor pressure, described by (1.10) coincide very well with experimental ones for water at  $q_{liq}^S = 3.1$  and for ice at  $q_{sol}^S = 18$  (Fig. 1.3).

The almost five-times difference between  $q_{sol}^S$  and  $q_{liq}^S$  means that the *surface* properties of ice differ from *bulk* ones much more than for liquid water.

### 1.3.5. Coincidence between calculated and experimental surface tension

The resulting surface tension is introduced in our mesoscopic model as a sum:

$$\sigma = (\sigma_{tr} + \sigma_{lb}) \quad 1.12$$

where:  $\sigma_{tr}$  and  $\sigma_{lb}$  are translational and librational contributions to surface tension. Each of these components can be expressed using our mesoscopic state equation (1.6), taking into account the



difference between surface and bulk total energies ( $q^S$ ), introduced in previous section:

$$\sigma_{tr} = \frac{1}{\frac{1}{\pi}(V_{lb_{ef}})_{tr,lb}^{2/3}} \left[ \frac{q^S P_{tot}(P_{ef} V_{ef})_{tr,lb} - P_{tot}(P_{ef} V_{ef})_{tr,lb}}{(P_{ef} + P_t)_{tr} + (P_{ef} + P_t)_{lb} + (P_{con} + P_{cMt})} \right] \quad 1.13$$

where  $(V_{ef})_{tr,lb}$  are volumes of primary tr and lib effectons, related to their concentration  $(n_{ef})_{tr,lb}$  as:

$$(V_{ef})_{tr,lb} = (1/n_{ef})_{tr,lb};$$

$$r_{tr,lb} = \frac{1}{\pi} (V_{ef})_{tr,lb}^{2/3}$$

is an effective radius of the primary translational and librational effectons, localized on the surface of condensed matter;  $q^S$  is the surface factor, equal to that used in vapor pressure calculations;  $[P_{tot} = P_{in} + P_{ext}]$  is a total pressure;  $(P_{ef})_{tr,lb}$  is a total probability of primary effecton excitations in the (a) and (b) states:

$$(P_{ef})_{tr} = (P_{ef}^a + P_{ef}^b)_{tr}$$

$$(P_{ef})_{lb} = (P_{ef}^a + P_{ef}^b)_{lb}$$

$(P_t)_{tr}$  and  $(P_t)_{lb}$  in (13) are the probabilities of corresponding transiton excitation;

$P_{con} = P_{ac} + P_{bc}$  is the sum of probabilities of [a] and [b] *convertons*;  $P_{cMt} = P_{ac} P_{bc}$  is a probability of Macroconvertons excitation.

The eq. (1.13) contains the ratio:

$$(V_{ef}/V_{ef}^{2/3})_{tr,lb} = l_{tr,lb} \quad 1.14$$

where:  $l_{tr} = (1/n_{ef})_{tr}^{1/3}$  and  $l_{lb} = (1/n_{ef})_{lb}^{1/3}$  are the length of the ribs of the primary translational and librational effectons, approximated by cube.

The resulting surface tension can be presented as:

$$\sigma = \sigma_{tr} + \sigma_{lb} = \pi \frac{P_{tot}(q^S - 1) \left[ (P_{ef})_{tr} l_{tr} + (P_{ef})_{lb} l_{lb} \right]}{(P_{ef} + P_t)_{tr} + (P_{ef} + P_t)_{lb} + (P_{con} + P_{cMt})} \quad 1.15$$

The results of computer calculations of  $\sigma$  (eq. 1.15) for water and experimental data are presented at Fig.1.4.

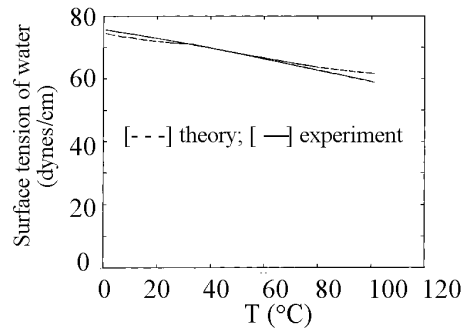

Figure 1.4. Experimental (—) and theoretical (---) temperature dependences of the surface tension for water. The experimental data were taken from Handbook of Chem. & Phys., 67 ed., CRC press, 1986-1987.

It is obvious, that the correspondence between theory and experiment is very good,

confirming in such a way the correctness of our model and Hierarchic concept in general.

### 1.3.6. Coincidence between calculated and experimental thermal conductivity

Thermal conductivity may be related to phonons, photons, free electrons, holes and [electron-hole] pairs movement. We will discuss here only the main type of thermal conductivity in condensed matter, related to phonons.

Hierarchic theory introduce two contributions to thermal conductivity: related to phonons, radiated by secondary effectons and forming *secondary* translational and librational deformons ( $\kappa_{sd})_{tr,lb}$  and to phonons, radiated by *a* and *b* convertons [*tr/lb*], forming the convertons-induced deformons ( $\kappa_{cd})_{ac,bc}$ :

$$\kappa = (\kappa_{sd})_{tr,lb} + (\kappa_{cd})_{ac,bc} = \frac{1}{3} C_v v_s [(\Lambda_{sd})_{tr,lb} + (\Lambda_{cd})_{ac,bc}] \quad 1.16$$

where: free runs of secondary phonons (tr and lb) are represented as:

$$1/(\Lambda_{sd})_{tr,lb} = 1/(\Lambda_{tr}) + 1/(\Lambda_{lb}) = (\bar{v}_d)_{tr}/v_s + (\bar{v}_d)_{lb}/v_s$$

consequently:

$$1/(\Lambda_{sd})_{tr,lb} = \frac{v_s}{(\bar{v}_d)_{tr} + (\bar{v}_d)_{lb}} \quad 1.17$$

and free runs of convertons-induced phonons:

$$1/(\Lambda_{cd})_{ac,bc} = 1/(\Lambda_{ac}) + 1/(\Lambda_{bc}) = (v_{ac})/v_s + (v_{bc})/v_s$$

The heat capacity:  $C_V = \partial U_{tot}/\partial T$  can be calculated also from our theory.

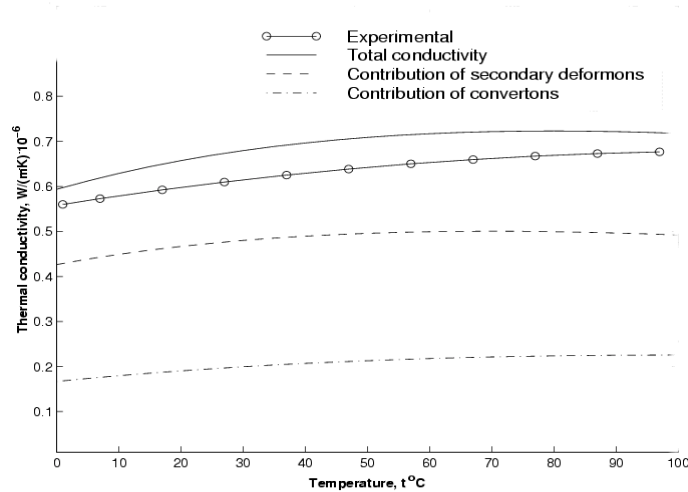

Figure 1.5. Temperature dependences of total thermal conductivity for water and contributions, related to acoustic deformons and [*lb/tr*]convertons. The experimental data were taken from Handbook of Chem. & Phys., 67 ed., CRC press, 1986-1987.

### 1.3.7. Coincidence between calculated and experimental viscosity for liquids and solids

The viscosity is determined by the energy dissipation as a result of medium (liquid or solid) structure deformation. Viscosity, corresponding to the shift deformation, is named *shear viscosity*. So- called *bulk viscosity* is related to deformation of volume parameters and corresponding dissipation. These types of viscosity have not the same values.

The new hierarchic theory of viscosity has been developed. The dissipation processes, related to ( $A \rightleftharpoons B$ )<sub>tr,lb</sub> cycles of translational and librational macroeffectons and (a,b)-convertons excitations were analyzed.

*In contrast to liquid state, the viscosity of solids* is determined by the biggest fluctuations:

supereffectons and superdeformons, resulting from simultaneous excitations of translational and librational macroeffectons and macrodeformons in the same volume.<sup>3</sup>

The contributions of translational and librational macrodeformons to resulting viscosity are present in following way:

$$\eta_{tr,lb}^M = \left[ \frac{E_D^M}{\Delta v_f^0} \tau^M \left( \frac{T_k}{U_{tot}} \right)^3 \right]_{tr,lb} \quad 1.18$$

where:  $(\Delta v_f^0)$  is the reduced fluctuating volume; the energy of macrodeformons:  $[E_D^M = -kT(\ln P_D^M)]_{tr,lb}$ .

The cycle-periods of the *tr* and *lb* macroeffectons has been introduced as:

$$[\tau^M = \tau_A + \tau_B + \tau_D]_{tr,lb} \quad 1.19$$

where: characteristic life-times of macroeffectons in A, B-states and that of transition state in the volume of primary electromagnetic deformons can be presented, correspondingly, as follows:

$$[\tau_A = (\tau_a \tau_{\bar{a}})^{1/2}]_{tr,lb} \quad \text{and} \quad [\tau_A = (\tau_a \tau_{\bar{a}})^{1/2}]_{tr,lb} \quad 1.20$$

$$[\tau_D = |(1/\tau_A) - (1/\tau_B)|^{-1}]_{tr,lb} \quad 1.21$$

Using (1.18 - 1.21) it is possible to calculate the contributions of  $(A \rightleftharpoons B)$  cycles of translational and librational macroeffectons to viscosity separately.

The averaged contribution of Macroexcitations (tr and lb) in viscosity is:

$$\eta^M = \left[ (\eta)_{tr}^M (\eta)_{lb}^M \right]^{1/2} \quad 1.22$$

The resulting theoretical viscosity (Fig. 1.6) was calculated as a sum of the averaged contributions of macrodeformons and convertons:

$$\eta = \eta^M + \eta_c \quad 1.23$$

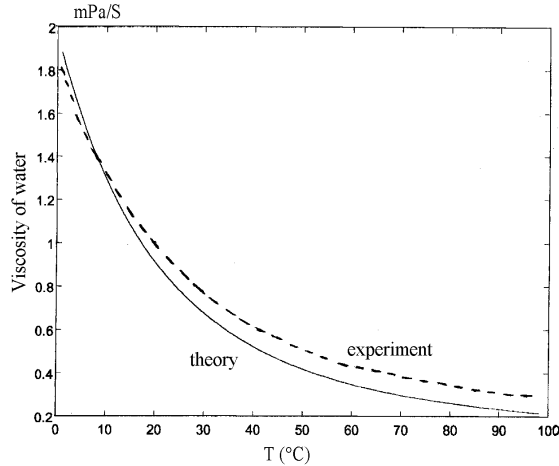

Figure 1.6. Theoretical and experimental temperature dependences of water viscosity. The experimental data were taken from Handbook of Chem. & Phys. 67 ed., CRC press, 1986-1987.

Like in the cases of thermal conductivity, viscosity and vapor pressure, the results of theoretical calculations of self-diffusion coefficient coincide well with experimental data for water in temperature interval  $(0 - 100^\circ\text{C})$ .<sup>3</sup> The coefficient of self-diffusion in solids also may be evaluated using the CAMP computer program.

The important conclusion, leading from the examples presented above, is that as far the final results of calculations are in a good accordance with experiment, it means that a lot of intermediate parameters, hidden from direct experiment, characterizing the spatial and dynamic properties of number of collective excitations of condensed matter - also correctly describe the matter properties.

#### 1.4 *New Optoacoustic Device, Based on Hierarchic Theory: Comprehensive Analyzer of Matter Properties (CAMP)*

The set of formulae obtained in our theory allows to calculate about 300 physical parameters of any condensed matter (liquid or solid). Most of them are hidden, i.e. inaccessible for direct experimental measurements.

Simulations evaluation of these parameters can be done using our computer program: CAMP (copyright 1997, Kaivarainen) and the following experimental methods:

1. Far-middle FT-IR or FT-Raman spectroscopy for determination the positions of translational or librational bands:  $(50-2500) \text{ cm}^{-1}$ ; 2. Sound velocimetry; 3. Densitometry; 4. Refractometry.

Corresponding data may be obtained at the same temperature and pressure from the same sample (liquid or solid), located in more than one cell and from the same cell for study of nonequilibrium dynamics or kinetic processes.

This leads to idea of new optoacoustic device: Comprehensive Analyzer of Matter Properties (CAMP), which may provide a huge amount of data of any condensed system under study.

The most complicated and expensive component of CAMP is FT-IR or FT-Raman or Brillouin spectrometer for registration of spectra in far and middle IR region. The most sensitive parameter is sound velocity.

One of possible CAMP configuration (Table 2) includes special attachment to FT-IR spectrometer (Harrick Scientific Co.), making it possible registration of reflection spectra in far/middle IR region and the refraction index dispersion. Such approach allows to study the properties of samples with strong IR absorption (i.e. aqueous systems) and non transparent mediums. For the other hand, the equipment, provided by Anton-Paar Co., makes it possible a simultaneous measurement of sound velocity and density.

Table 2. One of the possible configuration of Comprehensive analyzer of Matter Properties (CAMP)

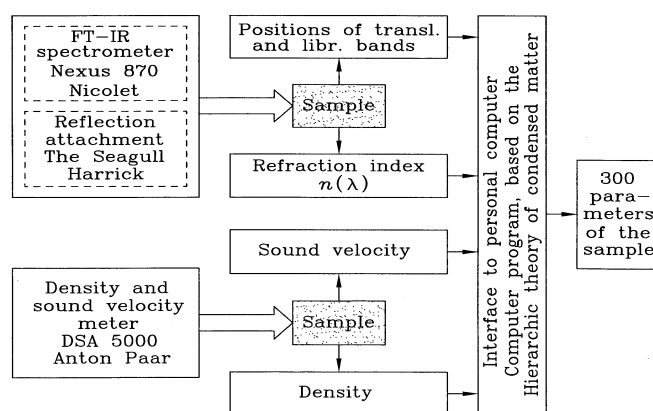

The unified system of modified FT-IR and/or Raman spectrometer, densitometer, sound velocimeter, refractometer, measuring the same sample at similar conditions is necessary to assembly. Simulation of corresponding parameters, using the interface of such system with

personal computer will provide CAMP function.

*The another configuration of CAMP* may include the FT-Brillouin light scattering spectrometer, based on Fabry-Perrot interferometer. It makes possible simultaneous measurement of hypersound velocity (from the Doppler shift of side bands of Brillouin spectra) and positions of intermolecular bands [tr and lb] from the Stokes/antiStokes satellite components on the central peak of Brillouin spectra. This means combination of possibilities of Raman spectroscopy and sound velocimetry.

CAMP may allow monitoring of perturbation of very different physical properties of condensed matter under the influence of solute molecules in dilute solutions and external electromagnetic or acoustic fields.<sup>7</sup>

Comprehensive Analyzer of Matter Properties (CAMP) represents a basically new type of scientific equipment, allowing to get incomparable big amount of information concerning physics of liquids or solids. It can be very useful for investigation of dynamics and mesoscopic structure of pure matter as well as solid and liquid solutions, the colloid systems and host-guest systems.

*The demo-version of CAMP-computer program is available and may be ordered from the author or directly downloaded from the front page of web site: [www.karelia.ru/~alexk](http://www.karelia.ru/~alexk) [see also 'Looking for partners']. This program demonstrates potential possibilities of new optoacoustic device on examples of water and ice.*

## **2. Water as a Regulating Factor of Biopolymers Properties and Evolution**

The dynamic model of proteins<sup>5</sup> leads to the following classification of dynamics in the native globular proteins (see also <http://arXiv.org/abs/physics/0003093>).

1. *Small-scale (SS) dynamics*: low amplitude (less than 1 Å) thermal fluctuations of atoms, aminoacids residues, and displacements of alpha - helices and beta - structures within domains and subunits, at which the effective Stokes radius of domains does not change. This type of motion can differ in the content of A and B conformers, corresponding to closed and open to water interdomain and intersubunit cavities. The range of characteristic times at SS dynamics of the surface aminoacids residues is around ( $10^{-10} - 10^{-12}$ ) sec., determined by activation energies of conformational transitions and microviscosity. It corresponds to calculated frequency of ( $a \rightleftharpoons b$ ) transitions of primary translational [tr] effectons (Fig. 2.2). The SS internal vibrations of aminoacids in rigid core of domains may be very slow  $\sim 10^4 s^{-1}$ ;

2. *Large-scale (LS) dynamics* is subdivided into *LS-pulsation* and *LS-librations* (see Fig.2.1) in form of limited diffusion of domains and subunits of proteins:

a) *LS-pulsations* are represented by relative translational-rotational displacements of domains and subunits at distances about 3 Å or more. Thus, big cavities of proteins, fluctuate between states of less (A) and more (B) water-accessibility. The life-times of these states depending on protein structure and external conditions are in the range of ( $10^{-4}$  to  $10^{-7}$ ) s. The [A - B] pulsations are accompanied by reversible sorption-desorption of (20 - 50) water molecules from the protein's cavities;

b) *LS-librations* represent the relative rotational - translational motions of domains and subunits in composition of A and B conformers with correlation times  $\tau_M \simeq (1 - 5) \cdot 10^{-8}$ s without [A - B] transitions.

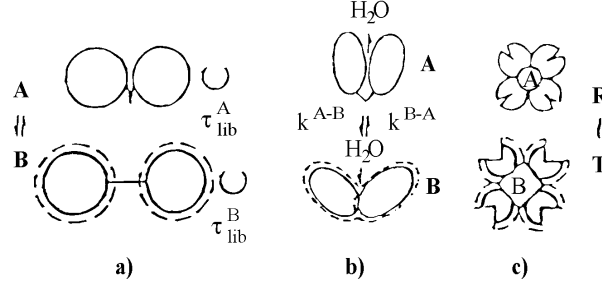

Figure 2.1 Examples of large-scale (LS) protein dynamics:  $A \leftrightarrow B$  pulsations and librations with correlation times ( $\tau_{\text{lib}}^B < \tau_{\text{lib}}^A$ ) (Kaivarainen, 1985, 1995): a) mobility of domains connected by flexible hinge or contact region, like in the light chains of immunoglobulins; b) mobility of domains that form the active sites of proteins, like in hexokinase, papain, pepsin, lysozyme etc. due to flexibility of contacts; c) mobility of subunits forming the oligomeric proteins like hemoglobin. Besides transitions of the active sites of each subunit, the ( $A \leftrightarrow B$ ) pulsations with frequencies of  $(10^4 - 10^6) \text{ s}^{-1}$  are pertinent to the common central cavity.

The librational mobility of domains and subunits is revealed by the fact that the experimental value of  $\tau_M$  is less than the theoretical one ( $\tau_M^t$ ) calculated on the Stokes-Einstein formula:

$$\tau_M^t = (V/k) \eta/T \quad 2.1$$

This formula is based on the assumption that the whole protein can be approximated by a rigid sphere. It means, that the large-scale dynamics can be characterized by the "flexibility factor", in the absence of aggregation equal to ratio:

$$fl = (\tau_M/\tau_M^t) \leq 1 \quad 2.2$$

LS - librations of domains are accompanied by "flickering" of water cluster in the open cavity between domains or subunits. The process of water cluster "flickering", i.e. [disassembly  $\rightleftharpoons$  assembly] is close to the reversible first-order phase transition, when:

$$\Delta G_{H_2O} = \Delta H_{H_2O} - T\Delta S_{H_2O} \approx 0 \quad 2.3$$

Such type of transitions in water-macromolecular systems could be responsible for so called "enthalpy-entropy compensation effects".

### 2.1 Role of water in dynamics of proteins

The "flickering clusters" means excitation of [ $lb/tr$ ] conversions between librational and translational primary water effectons, accompanied by [association/dissociation] of coherent water.

The water cluster (primary lb effecton) association and dissociation in protein cavities in terms of mesoscopic model represent the ( $ac$ ) - convertons or ( $bc$ ) - convertons. These excitations stimulate the LS- librations of domains in composition of B-conformer. The frequencies of ( $ac$ ) and ( $bc$ ) convertons, has the order of about  $10^8 \text{ c}^{-1}$ , like the frequency of primary librational effectons excitation. This value coincides well with experimental characteristic times for protein domains librations Fig 2.2 b. The ( $ac$ ) and ( $bc$ ) convertons represent transitions between similar states of primary librational and translational effectons: [ $a_{lb} \rightleftharpoons a_{tr}$ ] and [ $b_{lb} \rightleftharpoons b_{tr}$ ] (see Introduction).

For the other hand, the Macroconvertons, representing simultaneous excitation of ( $ac + bc$ ) convertons, are responsible for [ $B \rightleftharpoons A$ ] large-scale pulsations of proteins. The frequency of macroconvertons excitation is about  $5 \cdot 10^6 \text{ s}^{-1}$  at physiological temperatures (Fig.2.2c).

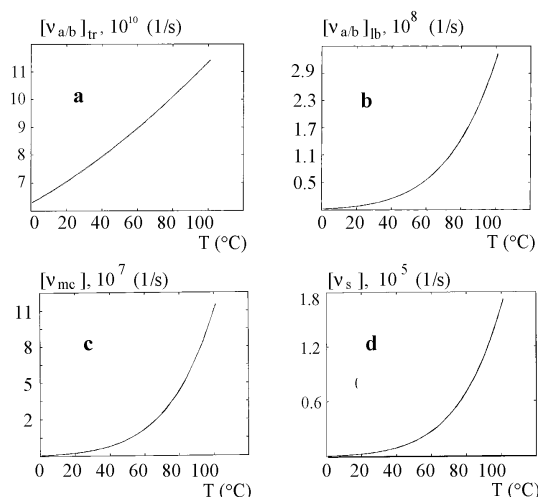

Figure 2.2. (a) - Frequency of primary  $[tr]$  effectons excitations;  
 (b) - Frequency of primary  $[lb]$  effectons excitations;  
 (c) - Frequency of  $[lb/tr]$  Macroconvertons (flickering clusters) excitations;  
 (d) - Frequency of Superdeformons excitations.

At the temperature interval  $(0-100)^{\circ}C$  the frequencies of translational and librational macrodeformons ( $tr$  and  $lb$ ) are in the interval of  $(1.3-2.8) \cdot 10^9 s^{-1}$  and  $(0.2-13) \cdot 10^6 s^{-1}$  correspondingly.

The calculated frequency of primary translational effectons  $[a \leftrightarrow b]_{tr}$  excitations at  $20^{\circ}C$  (Fig. 2.2 a) is  $\nu \sim 7 \cdot 10^{10} (1/s)$ . It corresponds to electromagnetic wave length in water  $\lambda = (cn)/\nu \sim 6mm$  with refraction index ( $n = 1.33$ ). For the other hand, there are a lot of evidence, that irradiation of very different biological systems with such coherent electromagnetic field exert great influences on their properties.

The frequency of Superdeformons excitation (Fig.2.2d) is much lower, than that of macroconvertons:  $\nu_s \sim (10^4 - 10^5) s^{-1}$ . Superdeformons are responsible for cavitational fluctuations in liquids and disassembly of protein filaments. The pulsation frequency of oligomeric proteins, like hemoglobin or disassembly (peptization) of actin and microtubules could be also related with such big fluctuations. The life-times of (A) and (B) conformer markedly exceeds the transition-time between them ( $10^{-9}$  to  $10^{-11}$ ) s.

*The (A - B) pulsations of various cavities in allosteric proteins are correlated.* The corresponding A and B conformers have different Stokes radii and effective volume. The geometrical deformation of the inter-subunits large central cavity of oligomeric proteins and the destabilization of the water cluster located in it, lead to relaxational change of (A - B) equilibrium constant, providing their cooperative properties.

At the temperature interval  $(0-100 C^{\circ})$  the frequencies of translational and librational macrodeformons ( $tr$  and  $lb$ ) are in the interval of  $(1.3-2.8) \cdot 10^9 1/s$  and  $(0.2-13) \cdot 10^6 s^{-1}$  correspondingly. It is obvious, that between the dynamics/function of proteins, membranes, etc. and dynamics of their aqueous environment the strong correlation exists.

## 2.2 The role of water in mechanism of protein-ligand specific complex formation and signal transmission between domains and subunits

According to our model of specific complexes formation the following order of events is assumed (Fig. 2.3):

1. Ligand (L) collides with the active site (AS), formed usually by two domains, in its open (b) state: the structure of water cluster in AS is being perturbed and water is forced out of AS cavity totally or partially;
2. Transition of AS from the open (b) to the closed (a) state occurs due to strong shift of  $[a \leftrightarrow b]$  equilibrium to the left, i.e. to the AS domains large scale dynamics;
3. A process of dynamic adaptation of complex  $[L+AS]$  begins, accompanied by the directed

ligand diffusion in AS cavity due to its domains small-scale dynamics and deformation of their tertiary structure;

4. If the protein is oligomeric with few AS, then the above events cause changes in the geometry of the central cavity between subunits in the open state leading to the destabilization of the large central water cluster and the shift of the  $A \rightleftharpoons B$ , corresponding to  $R \rightleftharpoons T$  equilibrium of quaternary structure leftward. Water is partially forced out from central cavity.

Due to the feedback mechanism this shift can influence the  $[a \leftrightarrow b]$  equilibrium of the remaining free AS and promotes its reaction with the next ligand. Every new ligand stimulates this process, promoting the positive cooperativity. The negative cooperativity also could be resulted from the interaction between central cavity and active sites;

5. The terminal [*protein – ligand*] complex is formed as a consequence of the relaxation process, representing deformation of domains and subunits tertiary structure. This stage could be much slower than the initial ones [1-3]. As a result of it, the stability of the complex grows up.

*Dissociation of specific complex* is a set of reverse processes to that described above which starts from the  $[a^* \rightarrow b]$  fluctuation of the AS cavity.

In multidomain proteins like antibodies, which consist of 12 domains, and in oligomeric proteins, the cooperative properties of  $H_2O$  clusters in the cavities can determine the mechanism of signal transmission from AS to the remote effector regions and allosteric protein properties.

The stability of a librational water effecton as coherent cluster strongly depends on its sizes and geometry. This means that very small deformations of protein cavity, which violate the [cavity-cluster] complementary condition, induce a cooperative shift of  $[A \leftrightarrow B]$  equilibrium leftward. The clusterphilic interaction, introduced earlier<sup>5,6</sup> turns to hydrophobic one due to  $[lb/tr]$  conversion.

This process can be developed step by step. For example, the reorientation of variable domains, which form the antibodies active site (AS) after reaction with the antigen determinant or hapten deforms the next cavity between pairs of variable and constant domains forming  $F_{ab}$  subunits (Fig.2.3). The leftward shift of  $[A \leftrightarrow B]$  equilibrium of this cavity, in turn, changes the geometry of the big central cavity between  $F_{ab}$  and  $F_c$  subunits, perturbing the structure of the latter. Therefore, the signal transmission from the AS to the effector sites of  $F_c$  subunits occurs due to the balance shift between clusterphilic and hydrophobic interactions. This signal may be responsible for complement- binding sites activation and triggering the receptors function on the lymphocyte membranes.

The leftward shift of  $[A \leftrightarrow B]$  equilibrium in a number of cavities in the elongated multidomain proteins can lead to the significant decrease of their linear size and dehydration. The mechanism of muscular contraction is probably based on such phenomena and clusterphilic interactions. The clusterphilic interactions means that interaction of the open protein cavity with water cluster is energetically more preferable, than with the same number of molecules after cluster disassembly.<sup>6</sup>

For such a nonlinear system the energy is necessary for reorientation of the first couple of domains only. The process then goes on spontaneously with decreasing the averaged protein chemical potential. The chemical potential of the A- conformer is usually lower than that of B- conformer ( $\bar{G}_A < \bar{G}_B$ ) and the relaxation of protein is accompanied by the leftward  $A \leftrightarrow B$  equilibrium shift of cavities, accompanied by decreasing of the averaged protein dimensions.

The shift of  $[A - B]$  equilibrium of central cavity of oligomeric proteins determines their cooperative properties during consecutive ligand binding in the active sites. Signal transmission from the active sites to the remote regions of macromolecules is also dependent of  $[A - B]$  equilibrium(Fig. 2.3).



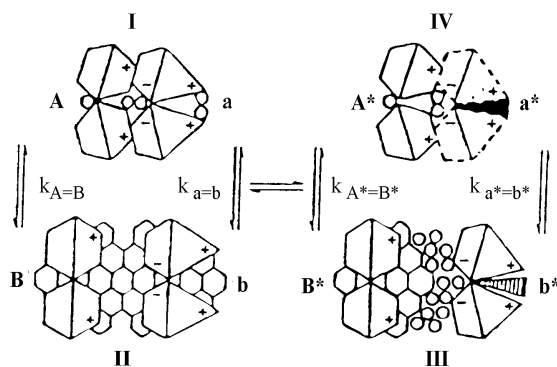

Figure 2.3. The schematic picture of the protein association (Fab subunits of antibody with a ligand), which is accompanied by destabilization of water clusters in cavities, according to dynamic model (Kaivarainen, 1985). The dotted line denotes the perturbation of the tertiary structure of the domains forming the active site. Antibodies of IgG type contain usually two such Fab subunit and one Fc subunit, conjugated with 2Fab by flexible hinge, forming the general Y-like structure.

The evolution of the ideas of the protein-ligand complex formation proceeded in the following sequence:

1. "Key-lock" or the rigid conformity between the geometry of an active site and that of a ligand (Fisher, 1894);
2. "Hand-glove" or the so-called principle of induced conformity (Koshland, 1962);
3. At the current stage of complex-formation process understanding, the crucial role of protein dynamics gets clearer. Our model allows us to put forward the "Principle of Stabilized Conformity (PSC)" instead that of "induced conformity" in protein-ligand specific reaction (Kaivarainen, 1985).

*Principle of Stabilized Conformity (PSC)* means that the geometry of the active site (AS), optimal from energetic and stereochemical conditions, is already existing *before* reaction with ligand. The optimal geometry of AS is to be the only one selected among the number of others and stabilized by ligand, but not induced "de nova".

### 2.3 The role of water in spatial parameters of proteins

The number of water molecules within the primary librational effectons of water, which could be approximated by a cube, decreases from 280 at (0C) to 3 at (100 C) (Fig. 2.4). It should be noted that at physiological temperatures (35-40 C) such quasiparticles contain nearly 40 water molecules. This number is close to that of water molecules that can be placed in the open interdomain protein cavities judging from X-ray data<sup>5</sup>.

Structural domains are space-separated units with a mass of  $(1-2) \cdot 10^{-3} D$ . Protein subunits, as a rule consist of two or more domains.

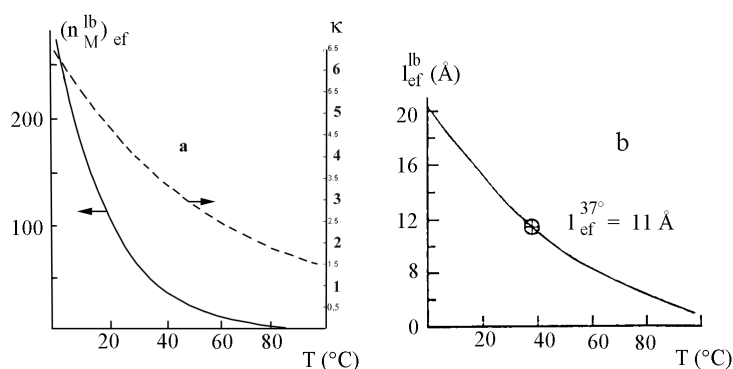

Figure 2.4. (a) : The temperature dependencies of the number of  $H_2O$  molecules in the volume of primary librational effecton  $(n_M^{lb})_{ef}$ , left axis) and the number of  $H_2O$  per length of this

effecton edge ( $\kappa$ , right axis); (b): the temperature dependence of the water primary librational effecton (approximated by cube) edge length [ $l_{ef}^{lb} = \kappa(V_0/N_0)^{1/3}$ ].

The number of  $H_2O$  molecules within the *primary librational effectons* of water, which could be approximated by a cube, decreases from  $n_M = 280$  at  $0^0$  to  $n_M \simeq 3$  at  $100^0$  (Fig. 3a). It should be noted that at physiological temperatures ( $35 - 40^0$ ) such quasiparticles contain nearly 40 water molecules. Similar by order dimensions of heavy water clusters (about  $10 \text{ \AA}$ ) with saturated hydrogen bonds were revealed using inelastic neutron scattering method by Texeira et al., in 1987.

The dimensions of water clusters are close to dimensions of the open interdomain protein cavities judging from X-ray data (Kaivarainen, 1985). The flickering of these clusters, i.e. their [disassembly  $\rightleftharpoons$  assembly] due to [lb\tr] conversions in accordance to our model is directly related to the large-scale dynamics of proteins, presented on Fig. 2.1).

It is important finding that the linear dimensions of the interdomain water clusters (about  $11 \text{ \AA}$ ) in 'open' states of protein cavities at physiological temperature, calculated using our software, are close to common ones for protein domains. Such spatial correlation indicate that the properties of water exerted a strong influence on the biological evolution of macromolecules, namely, their dimensions and allosteric properties due to cooperativity of intersubunit water clusters.

The correlation between dimensions of microtubules (about 10 microns) and wave-length of standing librational IR photons, composing primary electromagnetic deformons in water, points that not only spatial characteristics of biopolymers, but also the cell's dimensions are determined by water properties [1, 2]. Consequently, the calculations, based on our hierarchic theory, give a strong evidence, that water was one of the most important factors in evolution of biopolymers and cells.

The new mechanism of ATP hydrolysis energy utilization in muscle contraction and role of water in cancer also is presented in full paper <http://arXiv.org/abs/physics/0003093>.

### 3. Multi-Fractional Model of Interfacial Water Structure. Its Contribution to Morphogenetic Field

Our model of multi-fractional water structure, formed on solid-liquid interface, is based on Hierarchic theory of condensed matter.<sup>3,6</sup> Classification and description of FOUR interfacial water fractions, in accordance to our Multi-fractional model of interfacial (solid-liquid) water structure:

1. *The first fraction is Primary hydration Shell (PS)* with maximum energy of interaction with surface. The structure and dynamics of this 1st fraction can differ strongly from those of bulk water. Its thickness: corresponds to 1-3 solvent molecule. In accordance to generally accepted and experimentally proved models of hydration of macromolecules and colloid particles, we assume that PS of strongly bound water molecules, serves like intermediate shell, neutralizing the specific chemical properties of surface (charged, polar, nonpolar, etc.). Such strongly bound water can remain partially untouched even after strong dehydration of samples in vacuum. This 1st fraction of interfacial water serves like a matrix for second fraction - vicinal water shell formation. The properties of vicinal water are independent on specific chemical structure of the surface - from quartz plates, mineral grains and membranes to large macromolecules (Clegg and Drost-Hansen, 1991). This can be a result of "buffering" effect of primary hydration shell;<sup>8</sup>

2. *The second fraction - vicinal water (VW)* is formed by primary librational [lb] effectons - coherent molecular clusters with properties of mesoscopic Bose-condensate (mBC) with saturated hydrogen bonds and less density than the average one of bulk water. It is a result of [lb] effecton adsorption from the bulk volume on the primary hydration shell (PS). Vicinal water (VW) can be formed in the volume of pores, near the curved and plate interfaces as a result of interaction with strongly surface-bound water of PS.

The decreasing of most probable [lb] thermal momentums of water molecules, especially in

direction, normal to the surface of macromolecule or colloid particle as a consequence of interaction with primary shell (PS), should lead to increasing of corresponding edge's length of primary [lb] effectons, forming VW, as compared to the bulk water effectons. This selected immobilization of water molecules change the cube-like shape of effectons of the bulk water to shape of elongated parallelepiped for the effectons of VW. It is a result of increasing of corresponding wave B length of water molecules as a ratio of Plank constant to their most probable momentum.

The increasing of life-time of these enlarged primary [lb] effectons in the (a) state - means the increasing of their stability and concentration in the volume of VW.

As far we assume, that VW is a result of adsorption of primary librational effectons on primary hydration shell and their elongation in direction, normal to surface, we can make some predictions: a) The thickness of VW can be about 30-75 Å, depending on properties of surface (geometry, polarity), temperature, pressure and presence the perturbing solvent structure agents (the linear dimension of primary librational effecton of bulk water at 25°C is only about 15 Å); b) The elongation of primary [lb] effectons in direction, normal to the surface, should be resulted in increasing the intensity of librational IR photons superradiation in the same direction;<sup>6</sup> c) The vicinal water (VW) of second interfacial fraction should differ by number of physical parameters from the bulk water.

For example, VW should have: lower density; bigger heat capacity; bigger sound velocity; bigger viscosity; smaller dielectric relaxation frequency, etc. The lower mobility of water molecules of vicinal water is confirmed directly by almost 10 times difference of dielectric relaxation frequency ( $2 \cdot 10^9$  Hz) as respect to bulk one ( $19 \cdot 10^9$  Hz).<sup>8</sup> The increasing of temperature should lead to decreasing the vicinal librational effectons dimensions and thickness of VW shell;

3. *The third fraction of interfacial water*: surface-stimulated Bose-condensate (SS-BC) is represented by 3D network of primary [lb] effectons (mBC) with a thickness of (50-300 Å), stabilized by Josephson contacts. It is a next hierarchical level of interfacial water self-organization, using the second vicinal fraction (VW) as a matrix of nucleation centers for SS-BS. The time of gradual formation of this 3D net of linked to each other coherent clusters (strings of polyeffectons), can be much longer than that of VW and more sensitive to temperature and mechanical perturbations. The second and third fractions of interfacial water can play an important role in biological cells activity regulation;

4. The biggest and most fragile *forth fraction* of interfacial water is a result of slow orchestration of bulk primary effectons in the volume of primary (electromagnetic) [lb] deformons. The primary deformons appears as a result of superposition of three standing IR librational photons, normal to each other. Corresponding IR photons are radiated by the enlarged primary [lb] effectons of vicinal water and those of SS-BC. The linear dimension of librational IR deformons is about half of librational IR photons wave length, i.e. 5 microns.

This "electromagnetically orchestrated water (EM-OW)" fraction easily can be destroyed not only by temperature increasing, ultrasound and Browning movement, but even by mechanical shaking. The time of spontaneous reassemble of this fraction after destruction has an order of hours and is dependent strongly on temperature, viscosity and dimensions of colloid particles.

### 3.1 Possible role of interfacial water near cell's microfilaments in morphogenetic field formation

In biosystems, like living cells, the IR radiation of second (VW) and third (SS-BC) fractions of interfacial water, orchestrated in the internal core of microtubules (MT) and around MTs and actin filaments, may contribute to "morphogenetic field", revealed by A. Gurwich in form of EM field. Later it was confirmed in different laboratories, that EM radiation is accompanied the cells division and differentiation. The directed IR *superradiation* of interfacial water in cytoplasm should be dependent on orientation of microtubules and actin filaments. The known non-linear optical effect - "superradiation"<sup>9</sup> is a part of our Hierarchic theory of matter.<sup>3,5</sup> It is a consequence of water coherent clusters - mesoscopic Bose condensate (mBC) ability to quantum

beats between their optic and acoustic modes. Superradiation should be maximum from the ends of microtubules, in accordance with theory of this effect. Superposition of corresponding coherent IR photons can be responsible for formation of primary deformons, stimulating cavitation fluctuations in certain volumes of cytoplasmic water and reversible disassembly of MTs and actin filaments.

In accordance to our Hierarchic model of consciousness, described in next section, the intensity of IR coherent photons superradiation is maximum from the ends of microtubules (MTs). Their superposition leads to formation of hologram like system of primary deformons, responsible for distant cell-cell interaction and regulation of their cytoplasmic dynamics. The structure of microtubules is presented on Fig. 3.1.

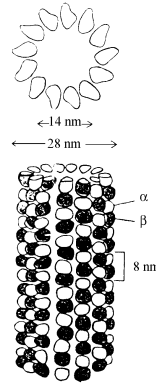

Figure 3.1. Construction of microtubule from  $\alpha$  and  $\beta$  tubulins, globular proteins with molecular mass 55 kD, existing in form of dimers ( $\alpha\beta$ ).

Each  $\alpha\beta$  dimer is a dipole with negative charges, shifted towards  $\alpha$  subunit. Consequently, microtubules, as an oriented elongated structure of dipoles system, have the piezoelectric properties (Athestaedt, 1974).

Hollow core of MT is has a diameter of 140 Å. All the internal water of MT may represent the 1st, 2nd and 3d fractions of interfacial water, described above. The spatial orientation of two bundles of MTs, containing about  $2 \cdot 25 = 50$  MTs is determined by orientation of two centrioles, forming as a rule the right angle (Fig 4.1). Consequently, the directions of penetration of IR librational photons, superradiated from the ends of MTs, usually fixed on cell's membrane, also have the almost right angle relative orientation. Interception of these coherent IR photons with those, superradiated by other cells leads to formation of 3D standing waves, i.e. IR primary [lb] deformons with linear dimension of 5 microns (  $1/2$  [lb] photon wave-length).

Distribution of density of inorganic ions, especially bivalent like  $\text{Ca}^{2+}$ , and probability of their fluctuations, affecting the water activity, should be regulated by anisotropy of the electric field tension in the volume of 3D electromagnetic standing waves. We suppose, that the corresponding spatial distribution of water activity ( $a_{\text{H}_2\text{O}}$ ) plays the important modulation role in proteins dynamics/function and dynamic equilibrium of [assembly  $\rightleftharpoons$  disassembly] of microtubules and actin filaments, responsible for cell's shape.

The process of cavitation fluctuations 'collapsing' with frequency of superdeformons excitation ( $\sim 10^4 \text{ Hz}$ ) is accompanied by high-frequency (UV and visible) "biophotons" radiation due to recombination of dissociated to hydroxyl and proton water molecules. These biophotons may be responsible for short range morphogenetic field in contrast to coherent IR photons, standing for long-range morphogenetic field.

This could be one of the possible mechanism of morphogenetic field action. The another component of morphogenetic field may be related with superposition of virtual replicas (VR) of DNA, microtubules, actin filaments, responsible for cells 3D structure. The notion of VR leads from our Unified model of Bivacuum and wave - corpuscle duality, as base for quantum entanglement, discussed in section 5 of this paper.

#### 4. Hierarchic Model of Consciousness: From Molecular Bose Condensation to Synaptic Reorganization

Our Hierarchic Model of Consciousness (HMC)<sup>10,11</sup> is based on Hierarchic Theory of Matter, developed by the author.<sup>3,5</sup>

The idea of Karl Pribram of his book: 'Languages of the Brain' (1977) of holographic principles of memory and braining is very popular in quantum models of consciousness. Our model also supports this general idea and try to transform it in concrete shape. The code way of keeping information in the form of the effectons and deformons as 3D standing waves (de Broglie waves, electromagnetic, acoustic and vibro-gravitational), generated by microtubules, containing water in state of mesoscopic Bose condensation (mBC) - looks very effective and may be used in quantum computer technology<sup>10</sup>.

Hameroff and Penrose<sup>12,13</sup> proposed the "orchestrated objective reduction (Orch OR)" model of quantum computation in microtubules (MT) of brain. They suppose, that quantum nonlocal interaction between huge number of MT may provide coherency of their thermal dynamics. Based on principle of uncertainty in coherent form it was calculated, that if the difference in volume of alternative states of very big number ( $10^9$ ) of dynamically coherent tubulin dimers ( $\alpha\beta$ ) is about 10% during 0.5 s (arbitrary assumption), the quantum gravity induced self-collapse to one quantum state may occur.

The idea of Penrose and Hameroff about quantum gravity induced self-collapse of MT system is compatible with our model, if we assume, that collapse is resulted from change of mass of fraction of mBC of water molecules in hollow core of microtubules, triggered by membranes depolarization. The  $mBC_{H_2O}$  of water and  $mBC_{MT}$  of microtubules may form the unified [water - protein] coherent quantum domains with dimensions of few nanometers, which may be regulated by ( $\alpha\beta$ ) dimers conformation and dynamics.

##### 4.1 Properties of Actin Filaments, Microtubules and Internal Water

The actin filaments are composed from two chains of G-actin, forming double helix with diameter of 40 Å. The actin filaments are the polar structure with different properties of two ends. Disassembly of actin and (*gel* → *sol*) transition is dependent strongly on water activity and energy of thermal fluctuation. Polymerization of actin do not needs energy. Simple increasing of salt concentration (decreasing of water activity), approximately till to physiological one - induce polymerization and strong increasing of viscosity in cytoplasm.

Microtubules sometimes can be as long as axons of nerve cells, i.e. tenth of centimeters long. Microtubules (MT) in axons are usually parallel and are arranged in bundles. Microtubules associated proteins (MAP) form a "bridges", linking MT and are responsible for their interaction and cooperative system formation. Brain contains a big amount of microtubules. *Their most probable length is about  $10^5$  Å.*

Strong interrelation must exist between properties of internal water in MT and structure and dynamics of their walls, depending on [ $\alpha - \beta$ ] tubulins interaction. The biggest cavitational fluctuations of internal water - (superdeformons) in the volume of 3D standing IR photons can induce total cooperative disassembly of MT, leading to [*gel* → *sol*] transition in cytoplasm. Superdeformons excitation in MT internal water could be an explanation of experimentally revealed dynamic instability (catastrophes).

The equilibrium of "closed" (A) and "open" (B) states of nonpolar cavities between  $\alpha$  and  $\beta$  tubulins in ( $\alpha\beta$ ) dimers can be shifted to the (B) one, under the change of external electric field in a course of membrane depolarization. It can be a consequence of piezoelectric properties of MTs and will stimulate the formation of coherent water clusters in the open nonpolar cavities of ( $\alpha\beta$ ) dimers. The open cavities can serve as a centers of molecular Bose condensation (mBC) in form of coherent water cluster.

The relative orientation of MT in different cells, optimal for maximum [MT-MT] resonance interaction by means of coherent IR photons, could be achieved due to twisting of centrioles,

changing spatial orientation of MT.

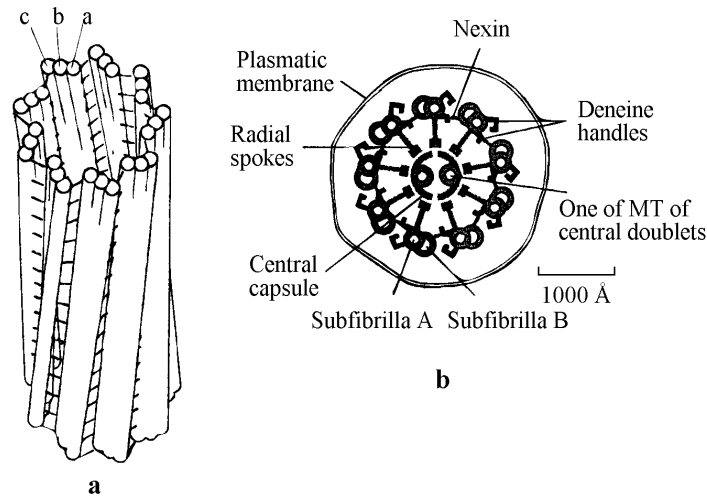

Figure. 4.1. (a) : The scheme of centriole construction from nine triplets of microtubules. The length and diameter of cylinder are 3000 Å and 1000 Å, correspondingly. Each of triplets contain one complete microtubule (MT) and two noncomplete MT; (b): the scheme of cross-section of cilia with number of MT doublets and MT-associated proteins (MAP):  $[2 \cdot 9 + 2] = 20$ . One of MT of periphery doublets is complete and another is noncomplete (subfibrilles A and B).

Results of our computer simulations for pure *bulk* water shows, that the distance between centers of primary [lb] effectons, approximated by cube exceed their linear dimension to about 3.5 times (Fig 4.2b). For our case of interfacial water in MTs, when the librational effecton's edge can be about 23 Å at physiological temperature, it means that the average distance between the effectons centers is about:  $d = l_{ef}^{lb} \cdot 3.5 = 23 \cdot 3.5 \sim 80 \text{Å}$ . This corresponds well to equidistant (80 Å) spacing between clefts of ( $\alpha\beta$ ) dimers in the internal core of MT. Such a regular spatial distribution of the internal flickering water clusters in MT is an important factor for realization of the [optoacoustic - conformational] signal propagation along the MT, accompanied by correlated radiation/absorption of librational ( $\sim 700 \text{cm}^{-1}$ ) IR photons and alternating closing *and* opening clefts between  $\alpha$  and  $\beta$  tubulins (see Fig. 4.3).

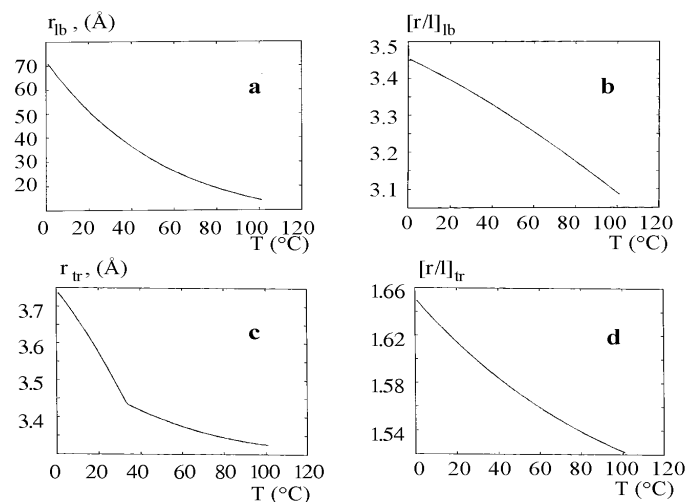

Figure. 4.2. Theoretical temperature dependencies of: (a) - the space between centers of primary [lb] effectons; (b) - the ratio of space between primary [lb] effectons to their length; (c) - the space between centers of primary [tr] effectons; (d) - the ratio of space between primary [tr] effectons to their length.

At the "rest" state the resulting concentration of internal anions of neurons is bigger than that

of external ones, providing the difference of potentials equal to 50-100 mV. As far the thickness of membrane is only about  $50\text{\AA}$ , it means that the gradient of electric tension is about:  $100.000\text{ V/cm}$  i.e. it is extremely high. It is changing strongly in the process of reversible depolarization of membranes.

The [gel-sol] transition, induced by cavitational fluctuations of water in cytoplasm (superdeformons) and MTs disassembly, can be accompanied by coherent "biophotons" emission/absorption in the ultraviolet (UV) and visible range. Such radiation is possible due to water molecules [dissociation  $\rightleftharpoons$  recombination] in a course of cavitational fluctuations. These high-frequency coherent photons exchange, like the IR photons and nerve impulses may be responsible for synchronized firing of distant neuron ensembles in head brain.<sup>14</sup> The firing is a complex nonlinear process. Its characteristic time of about 1/50 of second (20ms) is much longer than pure quantum phenomena in MTs.

One of the important consequence of our HMC is that interactions of distant neurons in head brain can be realized not only by means of nerve impulse propagation via axons. Simultaneous neurons excitation may be accompanied also by resonant photon exchange between MT of the 'tuned' distant neurons.

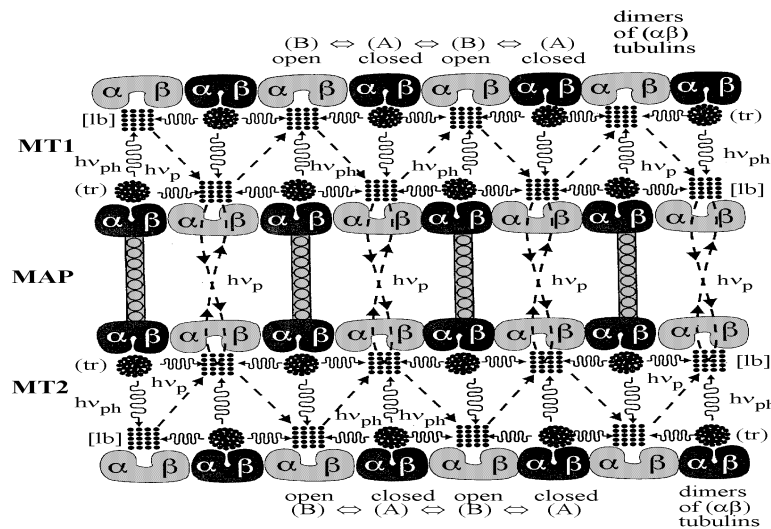

Figure .4.3 The schematic presentation of the local, acousto-conformational and distant - electromagnetic interactions between microtubules (MT1 and MT2), connected by MAP.

MAP- microtubules associated proteins stabilize the overall structure of MTs. They prevent the disassembly of MTs in bundles of axons and *cilia* in a course of their coherent bending. In neuron's body the concentration of MAP and their role in stabilization of MTs is much lower than in cilia. The local acousto-conformational signals between MT are realized via MTs - associated proteins (MAP), induced by transitions of the cleft, formed by  $\alpha$  and  $\beta$  tubulins, between closed (A) and open (B) states. The orchestrated dynamics of individual MT as quantum conductor is a result of phonons ( $h\nu_{ph}$ ) exchange between ( $\alpha\beta$ ) clefts due to [lb/tr] conversions, corresponding to water clusters, "flickering", in-phase to [ $B \rightleftharpoons A$ ] pulsations of clefts. The distant interactions between different MT are the consequence of IR photons and coherent vibro - gravitational waves exchange. The corresponding two types of waves are excited as a result of orchestrated ( $a \rightleftharpoons b$ ) transitions of water primary librational effectons, localized in the open B- states of ( $\alpha\beta$ ) clefts. Coherent disassembly or bending of MTs could be responsible for [volume/shape] pulsation of the nerve cells body or cilia bending. The former process is accompanied by redistribution of synaptic contacts on the surface of cells.

#### 4.3 Stages of Hierarchic Model of Consciousness

In accordance with our HMC, the sequence of following interrelated stages is necessary for elementary act of perception and memory (see Fig.2), resulted from simultaneous excitation and depolarization of big enough number of neurons, forming cooperative ensemble:

1. The change of the electric component of neuron's body internal electromagnetic field as a result of cells depolarization; 2. Opening the potential - dependent  $\text{Ca}^{2+}$  channels and increasing the concentration of these ions in cytoplasm. Activation of  $\text{Ca}^{2+}$  - dependent protein gelsolin, which stimulate fast disassembly of actin filaments; 3. Shift of  $A \rightleftharpoons B$  equilibrium between the closed (A) and open to water (B) states of cleft, formed by  $\alpha$  and  $\beta$  tubulins in tubulin pairs of microtubules (MT) to the right as a consequence of piezoelectric effect, induced by depolarization of membrane of nerve cell; 4. Increasing the life-time and dimensions of coherent "flickering" water clusters in MT, representing the 3D superposition of de Broglie standing waves of  $\text{H}_2\text{O}$  molecules in hollow core of MT. It is a result of the water molecules immobilization in the 'open' nonpolar clefts of ( $\alpha\beta$ ) dimers of MT; 5. Increasing the superradiance of coherent IR photons induced by synchronization of quantum transitions of the *effectons* between *acoustic* and *optic* like states. Corresponding increasing of probability of superdeformons (cavitational fluctuations) excitation in water of cytoplasm; 6. The *disassembly of actin filaments system to huge number of subunits, [gel $\rightarrow$ sol] transition and increasing of water fraction in hydration shell of proteins in cytoplasm*. This transition is a result of cavitational fluctuations and destabilization of actin filaments by  $\text{Ca}^{2+}$ . Corresponding decreasing the water activity in cytoplasm - increases strongly the passive osmotic diffusion of water from the external volume to the cell; 7. As a consequence of previous stage, a jump-way increasing of the nerve cell body volume (pulsation), accompanied by disrupting the (+) ends of MTs with cytoplasmic membranes occur. This stage makes it possible for MTs to change their orientation inside neuron's body; 8. Spatial "tuning" - collective reorientation of MTs of simultaneously excited neurons to geometry, corresponding to minimum potential energy of distant (but not nonlocal) electromagnetic and vibro-gravitational interaction between MTs and centrioles twisting; 9. Decreasing the concentration of  $\text{Ca}^{2+}$  to the critical one, when disassembly of actin filaments is stopped and [gel  $\rightleftharpoons$  sol] equilibrium shifts to the left again, stabilizing the new MTs system spatial configuration and corresponding nerve cell body volume and geometry. This new geometry of nerve cells after fixation of (+) ends of MTs back to plasmatic membrane - determine the new distribution of ionic channels activity and reorganization of synaptic contacts in all excited ensemble of neurons after relaxation, i.e. *short-term and long-term memory*.

This cyclic consequence (hierarchy) of quantum mechanical, physicochemical and classical nonlinear events can be considered as elementary acts of memorizing and consciousness. The total period of listed above stages can be as long as 500 ms, i.e. half of second.

The resonance wave number of excitation of superdeformons, leading from our model, is equal to 1200 ( $1/\text{cm}$ ). The experiments of Albrecht-Buehler<sup>15,16</sup> revealed that just around this frequency the response of surface extensions of 3T3 cells to weak IR irradiation is maximum. Our model predicts that IR irradiation of microtubules system *in vitro* with this frequency will dramatically increase the probability of microtubules catastrophes. It's one of the way to verify our model experimentally.

Except superradiance, two other known cooperative optic effects could be involved in supercatastrophe realization: *self-induced bistability and pike regime* of IR photons radiation. Self-induced bistability is light-induced phase transition. It could be related to nonlinear shift of [ $a \rightleftharpoons b$ ] equilibrium of primary librational water effectons in MT to the right, as a result of saturation of IR ( $lb$ )-photons absorption. As far the molecular polarizability and dipole moments in (a) and (b) states of the primary effectons - differs, such shifts of [ $a \rightleftharpoons b$ ] equilibrium should be accompanied by periodic jumps of dielectric permeability and stability of coherent water clusters. These shifts may be responsible for the pike regime of librational IR photons absorption and radiation. *As far the stability of b-states of lb effectons is less than that of a-states, the characteristic frequency of pike regime can be correlated with frequency of MTs - supercatastrophe activation.*

The Brownian effects, which influence reorientation of MTs system and probability of cavitational fluctuations, stimulating [gel - sol] transition in elementary act of consciousness - represent in our model the *non-computational element of consciousness*. Other models relate this



element to wave function collapsing.

#### 4.2 The entropy-driven information processing

It leads from our HMC that changes of system of electromagnetic, acoustic and vibro-gravitational 3D standing waves in the ensemble of nerve cells, produced by the internal water of MTs in a process of braining - may change the properties of this water in a course of MT system reorientation and 'tuning'.

This process induces redistribution of probabilities of different water excitations in huge number of microtubules. It means corresponding change of informational entropy  $\langle I \rangle$ :<sup>10,11</sup>

$$\langle I \rangle = \sum_i P_i \lg(1/P_i) = - \sum_i P_i \lg(P_i) \quad 4.1$$

where:  $P_i$  is a probability of the ( $i$ ) state with energy ( $E_i$ ), defined as:

$$P_i = \frac{\exp(-\frac{E_i}{kT})}{\sum_i \exp(-\frac{E_i}{kT})} \quad 4.2$$

For total system the relation between entropy (S) and information (I) is:

$$S(e.u.) = k \cdot \ln W = (k \cdot \ln 2)I = 2.3 \cdot 10^{-24} I (bit) \quad 4.3$$

where statistical weight of macro system is:

$$W = \frac{N!}{N_1! N_2! \dots N_q!} \quad 4.4$$

the total number of internal water molecules in macrosystem of interacting MT is:

$$N = N_1 + N_2 + \dots + N_q;$$

[ $q$ ] is number of non degenerated states of 24 quasiparticles of the internal water in MTs.

The *reduced information* of condensed matter (Kaivarainen, 2000d) to the number of molecules ( $n_i$ ) in each kind of excitations:

$$n_i = v_i/v_{H_2O} = (1/n_i)/(V_0/N_0) \quad 4.4a$$

- gives characteristic not only of quantity (I) but also about the quality of the information (**Iq**) for each collective excitation and their sum:

$$\langle \mathbf{Iq} \rangle = -[N_0/V_0] \cdot \sum_i P_i \lg_2(P_i)/n_i \quad 4.5$$

where  $N_0$  and  $V_0$  are the Avogadro number and molar volume;  $n_i$  is a concentration of excitation of ( $i$ )-type.

The distant energy exchange between MT, accompanied by the change of  $P_i$  for different excitations can be considered as an informational exchange between nerve cells. It is related to change of fractions of water excitations in system of interacting MTs.

#### *Audio/Video Signals Skin Transmitter, based on HMC*

We propose the idea of new device, where the laser beam with energy of cavitation fluctuations activation, corresponding to wave number 1200 ( $1/cm$ ), and ultraweak intensity will be modulated by acoustic and/or video signals. The modulated output optic signals will be transmitted from laser to the nerve nodes of skin, using wave-guides. It is supposed that the nerve impulses, stimulated by modulated laser beam, can propagate via complex axon-synapse system to brain centers, responsible for perception and processing of audio and video information. The long-term memorizing process also can be stimulated effectively by Skin Transmitter, as far it should increase the number of reorganized synaptic contacts.

The direct and feedback reaction between brain centers, responsible for audio and video information processing and certain nerve nodes on skin, like acupuncture points, is predictable.

There are another resonant EM frequencies also, different from cavitational ones, for example the macroconvertions frequency, enable to stimulate big fluctuations of water in MTs and their disassembly. Verification of these important consequences of our model and elaboration of Audio/Video Signals Skin - Transmitter is the intriguing task of future. The practical realization of Audio/Video Signals Skin Transmitter will be a good additional evidence in proof of HMC and useful for lot of people with corresponding diseases.

The selective *cancer cells degenerator*, based on different probability of water cavitation fluctuation stimulation in cytoplasm of normal and cancer cells, has been also proposed. The full paper on this subject is on-line <http://arXiv.org/abs/physics/0003045>).

## 5. Unified Model of Bivacuum, Matter & Fields. The Problem of Quantum Psi Phenomena

The coherent physical theory of psi-phenomena is absent yet due to its high complexity and multilateral character. It is clear also, that such *Quantum-Psi* theory should be based on new physical paradigm.

The original mechanism of *Bivacuum* mediated Mind-Matter and Mind-Mind interaction, proposed, is based on the following stages of our long term efforts (see [http://arXiv.org/find/physics/1/au:+Kaivarainen\\_A/0/1/0/all/0/1](http://arXiv.org/find/physics/1/au:+Kaivarainen_A/0/1/0/all/0/1)):

- Unified model of Bivacuum, [Corpuscle ( $C$ )  $\rightleftharpoons$  Wave ( $W$ )] duality of particles, Electromagnetism, Gravitation & Time. The Superfluous Energy of Asymmetric Bivacuum (<http://arXiv.org/abs/physics/0207027>);
- New Hierarchic theory of liquids and solids, verified on examples of water and ice by computer simulations (<http://arXiv.org/abs/physics/0102086>);
- New Hierarchic model of elementary act of consciousness, based on exchange interaction between microtubules of distant neurons by means of coherent IR photons, inducing the reversible [gel $\rightleftharpoons$ sol] transition in cytoplasm of neuron's body and synaptic reorganization (<http://arXiv.org/abs/physics/0003045>);
- Introducing the concept of Virtual Replica (VR) of matter and living organisms in Bivacuum, as a consequence of our Unified model (UM) (<http://arXiv.org/abs/physics/0103031>);
- The specific quantum and neurodynamics processes, responsible for 'Psi field';
- The role of local, nonlocal and distant Bivacuum mediated quantum phenomena, including quantum teleportation, in Mind-Matter and Mind-Mind interaction.

Unified Model (UM) represents the next stage of our efforts for unification of vacuum, matter, fields and time from few ground postulates.

New concept of Bivacuum is introduced, as a dynamic cell-type matrix of the Universe with superfluid and nonlocal properties, composed from non mixing *microscopic* sub-quantum particles of the opposite energies. We proceed from the important result of Dirac's theory, pointing to equal probability of positive and negative energy in the Universe. The collective quantum excitations of sub-quantum particles and antiparticles form the correlated pairs [*actual* rotor ( $V^+$ ) + *complementary* antirotor ( $V^-$ )], representing *mesoscopic double cells-dipoles*. The *macroscopic* structure of Bivacuum is formed by the infinitive number of these cells-dipoles, unified in form of virtual Bose condensate (VirBC) with nonlocal properties. The rotor ( $V^+$ ) and antirotor ( $V^-$ ) of cell-dipoles have the opposite quantized energy, virtual mass, spin, charge and magnetic moments.

In symmetric *primordial* Bivacuum, i.e. in the absence of matter and fields, the absolute values of all these parameters in each dipole are equal. The radiuses of *primordial* rotor and antirotor are equal to Compton radius vortex:  $[L^+ = L^- = L_0 = \hbar/m_0c]_{1,2,3}^i$ , where  $m_0^i$  is the rest mass of the electrons of three leptons generation ( $i = e, \mu, \tau$ ).

Such a cells-dipoles are named Bivacuum fermions ( $BVF^\uparrow = \mathbf{V}^+ \uparrow\uparrow \mathbf{V}^-$ ) and Bivacuum antifermions ( $BVF^\downarrow = \mathbf{V}^+ \downarrow\downarrow \mathbf{V}^-$ ). Their opposite half integer spins  $S = \pm \frac{1}{2}\hbar$ , notated as

( $\uparrow$  and  $\downarrow$ ), depend on direction of clockwise or anticlockwise rotation of pairs of [rotor ( $\mathbf{V}^+$ ) + antirotor ( $\mathbf{V}^-$ )], forming them. Bivacuum bosons ( $\mathbf{BVB}^\pm = \mathbf{V}^+ \updownarrow \mathbf{V}^-$ ) represent the intermediate state between  $\mathbf{BVF}^\uparrow$  and  $\mathbf{BVF}^\downarrow$ .

In *secondary* Bivacuum, in presence of matter and fields, the properties of rotors and antirotors do not compensate each other and  $\mathbf{BVF}^\updownarrow$  and  $\mathbf{BVB}^\pm$  turns to asymmetric. In such a conditions they acquire very small, but nonzero mass, momentum and charge.

*Virtual particles and antiparticles* in our model are the result of certain combinations of virtual clouds ( $\mathbf{VC}_{j,k}^+ \sim V_j^+ - V_k^+$ )<sup>*i*</sup> and anti clouds ( $\mathbf{VC}_{j,k}^- \sim V_j^- - V_k^-$ )<sup>*i*</sup>, composed from sub-quantum particles. Virtual clouds and anti clouds emission/absorption represents a correlated transitions between different excitation states (*j, k*) of rotors ( $V_{j,k}^+$ )<sup>*i*</sup> and antirotors ( $V_{j,k}^-$ )<sup>*i*</sup> of Bivacuum dipoles [ $\mathbf{BVF}^\updownarrow$ ]<sup>*i*</sup> and [ $\mathbf{BVB}^\pm$ ]<sup>*i*</sup>. Three generation of Bivacuum fermions correspond to three lepton generation (*i* = *e, μ, τ*).

The process of [*creation*  $\rightleftharpoons$  *annihilation*] of virtual clouds is accompanied by oscillation of *virtual pressure* ( $VP^\pm$ ) in form of *positive and negative virtual pressure waves* ( $VPW^+$  and  $VPW^-$ ), forming in certain conditions the autowaves in Bivacuum with properties of active medium. In primordial Bivacuum the virtual pressure waves:  $VPW^+$  and  $VPW^-$ , emitted/absorbed in a course of exchange interaction between [ $\mathbf{BVF}^\uparrow$  and  $\mathbf{BVF}^\downarrow$ ]<sup>*i*</sup> of opposite spins, totally compensate each other. However, in asymmetric secondary Bivacuum, in presence of matter and fields such compensation of virtual clouds ( $\mathbf{VC}_{j,k}^+$ ) and anti clouds ( $\mathbf{VC}_{j,k}^-$ ) is perturbed and the resulting pressure of virtual particles or antiparticles becomes nonzero. This displays, for example, in Casimir effect. In contrast to real particles, the virtual ones may exist only in the wave [W] phase, but not in corpuscular [C] phase (see Section 3). It is a reason, why [ $VPW^\pm$ ] and their superposition in form of the virtual autowaves do not obey the laws of relativist mechanics and causality principle.

The correlated by virtual clouds exchange of interaction pairs of Bivacuum fermions ( $\mathbf{BVF}$ ) with opposite spins ( $S = \pm \frac{1}{2} \hbar$ ) :

$$[\mathbf{BVF}^\uparrow \bowtie \mathbf{BVF}^\downarrow]_{S=0} \equiv [(V^+ \upuparrows V^-) \bowtie (V^+ \down\downarrow V^-)]_{S=0} \quad 5.1$$

have a properties of massless Goldstone bosons with zero spin:  $S = 0$ .

Superposition of their virtual clouds, emitted and absorbed in a course of correlated transitions of [ $\mathbf{BVF}^\uparrow \bowtie \mathbf{BVF}^\downarrow$ ]<sub>S=0</sub> compensate the virtual energy of each other:

$$\mathbf{BVF}^\uparrow \equiv (V^+ \upuparrows V^-) \quad 5.2$$

$$\updownarrow \quad \rightleftharpoons [\mathbf{VC}_{j,k}^+ - \mathbf{VC}_{j,k}^-]_{S=0} \rightarrow 0$$

$$\mathbf{BVF}^\downarrow \equiv (V^+ \down\downarrow V^-) \quad 5.3$$

Each of Bivacuum fermions has a properties of massless Goldstone fermions (Goldstino). At the absence of Bivacuum supersymmetry breach (primordial Bivacuum)  $\mathbf{BVF}^\updownarrow$  is a neutral particle.

The sub-elementary particles: *fermions and antifermions* ( $\mathbf{F}_\updownarrow^+$  and  $\mathbf{F}_\updownarrow^-$ ) of the opposite charge (+/-) and energy, composing the matter, emerge due to stable symmetry violation between the *actual* ( $V^+$ ) and *complementary* ( $V^-$ ) rotors of  $\mathbf{BVF}^\updownarrow$  cells-dipoles: [ $\mathbf{BVF}^\updownarrow \rightarrow \mathbf{F}_\updownarrow^\pm$ ]. The spatial image of [C] phase of sub-elementary particle represents the [actual rotor + complementary vortex] dipole, corresponding to the [actual mass ( $m_C^+$ ) + complementary mass ( $m_C^-$ )] dipole. The spatial image of [W] phase in form of cumulative virtual cloud (CVC) of sub-quantum particles is a parted hyperboloid.

Asymmetric double cells in form of [actual vortex + complementary rotor] dipoles, representing sub-elementary particles, get the ability to move as respect to symmetric ones with external group velocity  $v_{gr}^{ext} > 0$ . They acquire also the mass and charge, as a difference between their actual and complementary values. The quantum beats between such asymmetric (excited) and former symmetric (ground) shape of double cells represents, in accordance to our Unified

model, the [corpuscle (C)  $\rightleftharpoons$  wave (W)] pulsation. These transitions are accompanied by jump-way propagation in space the triplets of asymmetric dipoles in certain combinations, representing elementary particles.

The sub-elementary particles: *fermions and antifermions* ( $\mathbf{F}_{\uparrow}^+$  and  $\mathbf{F}_{\uparrow}^-$ ) of the opposite charge (+/-) and energy, composing the matter, emerge due to stable symmetry violation between the actual ( $V^+$ ) and complementary ( $V^-$ ) rotors of  $BVF^{\dagger}$  cells-dipoles:  $[BVF^{\dagger} \rightarrow \mathbf{F}_{\uparrow}^{\pm}]$  (Fig. 5. 1).

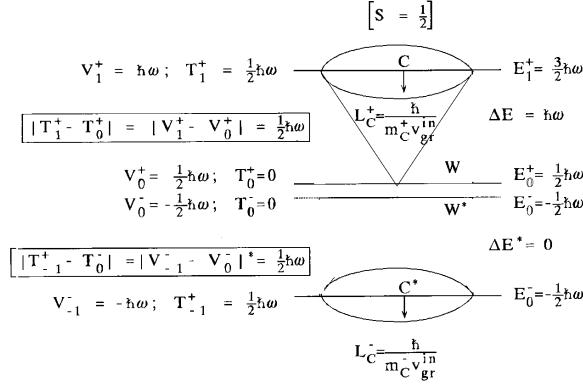

Fig.5.1. The spatial image of [C] phase of sub-elementary particle in form of [actual rotor + complementary vortex] dipole, corresponding to the [actual mass ( $m_C^+$ ) + complementary mass ( $m_C^-$ )] dipole.

Asymmetric double cells in form of [vortex + rotor] dipoles, representing sub-elementary particles, get the ability to move as respect to symmetric ones with external group velocity  $v_{gr}^{ext} > 0$ . The pulsation between such asymmetric (excited) and former symmetric (ground) shape of double cells represents, in accordance to our Unified model, the [corpuscle (C)  $\rightleftharpoons$  wave (W)] transitions. These transitions are accompanied by jump-way propagation of triplets of asymmetrically excited double cells in certain combinations, representing elementary particles.

The existence of different 3D structures of virtual autowaves, formed by  $VPW^{\pm}$ , modulated by external EM, gravitational fields and matter dynamics, are also the important feature of secondary Bivacuum. The notion of Virtual Replica (VR) of condensed matter is introduced,<sup>17</sup> as a multidimensional standing  $VPW^{\pm}$ , forming the autowaves in Bivacuum under the influence of hierarchy of matter quantum and molecular dynamics.

### 5.1 Conservation Rules for Bivacuum Fermions ( $BVF^{\dagger}$ ) and sub-Elementary Particles ( $F_{\uparrow}^{\pm}$ ), as a Mass, Magnetic and Electric Dipoles of Bivacuum

Two internal conservation rules, responsible for stability of  $BVF^{\dagger}$  and **sub-elementary** particles and antiparticles ( $\mathbf{F}_{\uparrow}^+$  and  $\mathbf{F}_{\uparrow}^-$ ), forming elementary particles of all three generations ( $i = e, \mu, \tau$ ), are postulated in our Unified Model (UM).

**I.** Conservation rule of the actual and complementary internal kinetic energies of vortex and antivortex:  $V^+$  and  $V^-$  of  $BVF^{\dagger} = [V^+ \uparrow V^-]^i$  and their asymmetric vortex and rotor states of  $F_{\uparrow}^{\pm} = [V^+ \uparrow V^-]^{i*}$ , correspondingly, in form of equality of modules of the internal actual  $|2T_{kin}^+|^{in}$  and complementary  $|-2T_{kin}^-|^{in}$  kinetic energies to the rest mass energy ( $m_0c^2$ ):

$$\left[ |2T_{kin}^+|^{in} = |m_C^+|(v_{gr}^{in})^2 = |-2T_{kin}^-|^{in} = |-m_C^-|(v_{ph}^{in})^2 = m_0c^2 = const \right]^i \quad 5.4$$

where the product of *internal* group ( $v_{gr}^{in}$ ) and phase ( $v_{ph}^{in}$ ) velocities is equal to product of *external* group ( $v_{gr} \equiv v_{gr}^{ext}$ ) and phase ( $v_{ph} \equiv v_{ph}^{ext}$ ) velocities of sub-elementary particle in composition of elementary particle:

$$v_{gr}^{in} v_{ph}^{in} = v_{gr} v_{ph} = c^2 \quad 5.5$$

From (5.4), taking into account (5.5), we get for the ratio of complementary ( $m_{\bar{C}}$ ) and actual ( $m_C^+$ ) mass of sub-elementary particle:

$$\frac{|m_{\bar{C}}|}{m_C^+} = \left[ \frac{v_{gr}^{in}}{v_{ph}^{in}} \right]^2 = \left[ \frac{(v_{gr}^{in})^2}{c^2} \right]^2 \quad 5.6$$

The resulting internal momentum of sub-elementary fermion squared ( $P_0^2 = m_0^2 c^2$ ) is permanent and equal to Compton's one:

$$\begin{aligned} P_0^2 &= P^+ P^- = (m_C^+ v_{gr}^{in})(|-m_{\bar{C}}| v_{ph}^{in}) = (m_C^+ v_{gr})(|-m_{\bar{C}}| v_{ph}) = \\ &= m_0^2 c^2 = \frac{\hbar^2}{L_0^2} = const; \quad P_0 = m_0 c \end{aligned} \quad 5.7$$

where the permanent resulting radius of sub-elementary particle, as a [vortex + rotor] dipole is equal to Compton vorticity radius, determined by particle's rest mass ( $m_0$ ):

$$L_0 = \frac{\hbar^2}{m_0 c} = (L^+ L^-)^{1/2} \quad 5.8$$

where for each sub-elementary particle, the radius of actual vortex is  $L^+ = \hbar/(m_C^+ v_{gr}^{in}) = \hbar/P^+$  and the radius of complementary rotor:  $L^- = \hbar/(|-m_{\bar{C}}| v_{ph}^{in}) = \hbar/P^-$ .

As far from (5.4) we have:

$$(2T_k^+)^{in} = \frac{(P^+)^2}{m_C^+} = (2T_k^-)^{in} = \frac{(P^-)^2}{|-m_{\bar{C}}|} = m_0 c^2 \quad 5.9$$

we get for the ratio of cross section of the actual vortex [ $S^+ = \pi(L^+)^2$ ] and complementary rotor [ $S^- = \pi(L^-)^2$ ]:

$$\frac{S^+}{S^-} = \frac{(L^+)^2}{(L^-)^2} = \frac{(P^-)^2}{(P^+)^2} = \frac{|-m_{\bar{C}}|}{m_C^+} = 1 - (v/c)^2 \quad 5.10$$

where, in accordance to our model:  $|-m_{\bar{C}}| = m_0[1 - (v/c)^2]^{1/2}$  and  $m_C^+ = m_0/[1 - (v/c)^2]^{1/2}$

In *primordial Bivacuum*, when sub-elementary particles  $F_{\uparrow}^{\pm}$  are absent, the properties of rotors and antirotors of BVF $^{\dagger}$  are characterized by equalities:

$$\begin{aligned} m_C^+ &= |-m_{\bar{C}}| = m_0 \\ v_{gr}^{in} &= v_{ph}^{in} = c \\ (2T_k^+)^{in} &= (2T_k^-)^{in} = (2T_k^0) = P_0^2/m_0 \end{aligned} \quad 5.10a$$

In slightly asymmetric *secondary Bivacuum* in presence of matter and fields, the equalities (5.10a) for BVF $^{\dagger}$  are perturbed or broken.

**II. Conservation of the absolute values of the internal actual ( $\mu_+$ ) and complementary ( $\mu_-$ ) magnetic moments of vortex and antivortex:  $V^+$  and  $V^-$  of Bivacuum fermions:**

$BVF^{\dagger} = [V^+ \uparrow V^-]^i$  and their asymmetric states: vortex and rotor of sub-elementary particles:

$F_{\uparrow}^{\pm} = [V^+ \uparrow V^-]^i$ , correspondingly, in form of the equality of their modules to the Bohr magneton ( $\mu_B^{\pm}$ ):

$$|\pm\mu_{\pm}| \equiv \frac{1}{2} |e_{\pm}| \frac{|\pm\hbar|}{|m_C^{\pm}| v_{gr}^{in}} = |\pm\mu_{\pm}| \equiv \frac{1}{2} |-e_{\pm}| \frac{|\pm\hbar|}{|-m_{\bar{C}}| v_{ph}^{in}} = \mu_B \equiv \frac{1}{2} |e| \frac{\hbar}{m_0 c} = const \quad 5.11$$

where:  $e_+$  and  $e_-$  are the *internal* electric charges of actual vortex and complementary rotor, correspondingly;  $|e|$  is a module of the resulting charge of the electron or positron.

The parameters:  $|e_{\pm}|$ ,  $|m_C^{\pm}|$  and  $v_{gr}^{in}$  are not permanent, in contrast to magnetic moments:

$|\pm\mu_+| = |\pm\mu_-| = \mu_B$  and ratios:

$$\frac{|e_+|}{|m_C^+|v_{gr}^{in}} = \frac{|-e_-|}{|-m_C^-|v_{ph}^{in}} = const \quad 5.11a$$

Such a difference between variable electric and permanent magnetic charges of Bivacuum explains the absence of MONOPOLE in Nature (see also eqs. 5.31 and 5.31a).

For the case of *primordial Bivacuum* (in the absence of matter and fields), when  $v = v^{ext} = 0$  and  $v_{gr}^{in} = v_{ph}^{in} = c$ , we have from (5.10) and (5.11) for BVF<sup>†</sup>:

$$|m_C^+| = |-m_C^-| = m_0 \quad 5.12$$

$$|e_+| = |e_-| = e \quad 5.12a$$

$$v_{gr}^{in} = v_{ph}^{in} = c \quad 5.12b$$

$$|\pm\mu_+| = |\pm\mu_-| = \mu_B = const \quad 5.12c$$

In slightly asymmetric *secondary Bivacuum* in presence of matter and fields, the equalities (5.12-5.12b) for BVF<sup>†</sup> are broken, however 5.12c remains unchanged, as well, as for sub-elementary particles.

The resulting magnetic moments of sub-elementary fermion/antifermion ( $\mu_F^\pm$ ), equal to the Bohr's magneton ( $\mu_B$ ), we get, as the actual  $|\mu_+|$  and complementary  $|\mu_-|$  components product average:

$$\mu_F^\pm = (|\mu_+||\mu_-|)^{1/2} = \left[ \left( \frac{|e|}{m_0c} \right)^2 \frac{\hbar^2}{4} \right]^{1/2} = \frac{|e|\hbar}{m_0c} \frac{1}{2} = \mu_B = const \quad 5.13$$

where:  $|e|^2 = |e_+e_-|$

For the other hand, the well known formula for the *normal* spin magnetic moment of the electron is:

$$\mu_S = \frac{e}{m_0c} \mathbf{S} \quad 5.14$$

where:  $[e/m_0c]$  is gyromagnetic ratio of the electron.

It follows from our model, that:  $\mu_F^\pm = \mu_B = \mu_S^\pm$ . Consequently, from eqs. (5.13 and 5.14) we get the value of the electron's spin and definition of the Plank constant, leading from our model of sub-elementary particles:

$$\mathbf{S} = \pm \frac{1}{2} \hbar \quad 5.15$$

$$where: \pm \hbar = \pm \sqrt{|m_C^+||i^2m_C^-|(v_{gr}^{in}v_{ph}^{in})(L^+L^-)} = \pm \sqrt{m_0^2c^2L_0^2} \quad 5.16$$

From (5.11) we get, that the *internal resulting electric dipole* ( $\mathbf{d}_{el}^{in}$ ) of sub-elementary particles/antiparticles are related to that of magnetic dipole and the Bohr magneton, as:

$$|\mathbf{d}_{el}^{in}| = [(|e_+||\mathbf{L}^+|)(|-e_-||\mathbf{L}^-|)]^{1/2} = eL_0 = 2|\mu_F^\pm| = 2\mu_B \quad 5.17$$

On the distance  $r \gg L_0 = \frac{\hbar}{m_0c}$ , the electric and magnetic dipole radiations, emitted in a course of in-phase  $[C \rightleftharpoons W]$  pulsation of sub-elementary particles or antiparticles should be equal, in accordance with existing theory of dipole radiation.

## 5.2 The Actual & Complementary Mass and Charge Compensation Principles.

### Extension of the Einstein's and Dirac's formalism for free relativistic particles

From (5.4 and 5.5) follows the *actual* ( $m_C^+$ ) & *complementary* ( $-m_C^- = i^2m_C^-$ ) *mass compensation principle*:

$$|m_C^+||i^2m_C^-| = m_0^2 \quad 5.18$$

$$\text{or : } |m_C^+m_C^-| = m_0^2 \quad 5.18a$$

where actual (inertial) and complementary (inertialess) mass have the opposite relativist dependence on the external group velocity:

$$|m_C^+| = m_0/[1 - (v/c)^2]^{1/2} \quad 5.19$$

$$|m_C^-| = m_0[1 - (v/c)^2]^{1/2} \quad 5.19a$$

From the ratio of (5.19a) to (5.19), we get the formula, similar to (5.10):

$$\frac{|m_C^-|}{|m_C^+|} = 1 - (v/c)^2 = \frac{S^+}{S^-} \quad 5.20$$

The eqs. 5.19 and 5.19a a can be transformed to following shape:

$$(E_C^+)^2 = (m_C^+)^2c^4 = m_0^2c^4 + (m_C^+v)^2c^2 \quad 5.21$$

$$(E_C^-)^2 = (m_C^-)^2c^4 = m_0^2c^4 - (m_0v)^2c^2 \quad 5.21a$$

where:  $E_C^+$  and  $E_C^-$  are the actual and complementary energy of wave B, correspondingly.

The first eq. (5.21) coincides with those, obtained by Dirac. The second (5.21a) for complementary energy is a new one and reflects the generalization of special theory of relativity and Dirac's theory for relativist particles.

From (5.11; 5.5a and 5.18) follows the internal *actual & complementary charge compensation principle*, symmetric to *mass compensation principle*:

$$|e_+||i^2e_-| = [i^2e]^2 \quad 5.22$$

$$\text{or : } |e_+e_-| = (e)^2 \quad 5.22a$$

The positive *actual* and negative *complementary* internal negative charges:  $[e_+]$  and  $[i^2e_-]$ , correspond to *vortex* and *rotor* of sub-elementary fermions.

*One can see, that the rest mass squared (2.7) and resulting charge squared (2.11a) are not dependent on the external group velocity (v), i.e. they are relativist invariants.*

### 5.3 Duality, as a Result of Quantum Beats Between the Actual and Complementary States of sub-Elementary Particles

Duality of elementary particles and antiparticles in accordance to Unified model, is a consequence of coherent quantum beats of their sub-elementary particles/antiparticles between two states: the asymmetrically excited state  $(BVF^\dagger)^* \equiv \mathbf{F}_\dagger^\ddagger$  and its symmetric state  $(BVF^\dagger)$ :

$$\left[ \mathbf{F}_\dagger^\ddagger \stackrel{CVC}{\rightleftharpoons} BVF^\dagger \right]^i \quad 5.23$$

where:  $i$  means *three electron's or positron's* generation:  $i = e, \mu, \tau$ .

These beats are accompanied by [emission  $\rightleftharpoons$  absorption] of cumulative virtual cloud (CVC) of sub-quantum particles, representing [W] phase of sub-elementary particle, oscillation of the mass and charge symmetry shift.

As far the energy of symmetric  $BVF^\dagger$  is equal to zero, it means that the energy of corpuscular [C] phase, in form of sub-elementary particle  $[\mathbf{F}_\dagger^\ddagger]$  is equal to energy of the wave [W] phase, in form of [CVC]:  $E_C = E_W$ .

The energy of quantum beats in a course of  $[C \rightleftharpoons W]$  pulsation of sub-elementary particle is equal to difference of energy between the absolute values of actual (vortex) and complementary (rotor) states. We get the energy of sub-elementary de Broglie wave in [C] and [W] phase, its relation to de Broglie wave frequency  $(\omega_0 = \omega_{C \rightleftharpoons W})^i$  and the wave length  $(\lambda_{C,W})$ , equal in both

phase, as a sum of rotational and two translational contributions:

$$[E_{C \rightleftharpoons W} = \hbar\omega_{C \rightleftharpoons W} = E_C = E_W = [|m_C^+|c^2 - |m_C^-|c^2]_{tot}^i = [(m_C^+)_{tot} v_{res}^2]^i = \quad 5.24$$

$$= [(E_{C,W}^S)_{rot} + (E_{C,W})_{\parallel tr} + (E_{C,W})_{\perp tr}]^i = |m_C^+ - m_C^-|_{rot} c^2 + |m_C^+ - m_C^-|_{\parallel tr} c^2 + |m_C^+ - m_C^-|_{\perp tr} c^2 \quad 5.24a$$

$$= m_0 \omega_0^2 L_0^2 + \alpha \frac{p^2}{m_C^+} + \beta \frac{p^2}{m_C^-} = 2(T_k)_{rot} + 2(T_k)_{\parallel tr} + 2(T_k)_{\perp tr} = \quad 5.24b$$

$$= m_0 c^2 + m_0 c^2 \frac{(v_{\parallel}/c)^2}{[1 - (v_{\parallel}/c)^2]^{1/2}} + m_0 c^2 \frac{(v_{\perp}/c)^2}{[1 - (v_{\perp}/c)^2]^{1/2}} \quad 5.24c$$

$$\text{or : } (E_C = E_W)_{\parallel, \perp tr} = \frac{\hbar^2}{m_C^+ \lambda_{\parallel, \perp}^2} \quad \text{where : } \lambda_{\parallel, \perp} = \frac{\hbar}{m_C^+ v_{\parallel, \perp tr}} = \frac{\hbar}{|m_C^+ - m_C^-| c^2 / v_{\parallel, \perp tr}} \quad 5.24d$$

where:

$$(m_C^+)_{tot} = m_0 + m_C^+_{\parallel tr} + m_C^+_{\perp tr}; \quad 5.26$$

$$m_C^+_{\parallel tr} = m_0 \frac{1}{[1 - (v_{\parallel}/c)^2]^{1/2}}; \quad m_C^+_{\perp tr} = m_0 \frac{1}{[1 - (v_{\perp}/c)^2]^{1/2}}$$

- the rotational (spin) contribution to energy is:  $(E_{C,W}^S)_{rot} = m_C^+ v_{rot}^2 = m_0 c^2 = m_0 \omega_0^2 L_0^2$ , where the rest mass ( $m_0 = |m_C^+ - m_C^-|^\phi$ ) is determined by difference of the actual vortex mass  $|m_C^+|$  and complementary rotor mass  $|m_C^-|$  at Golden mean conditions (see section 4.2 at <http://arXiv.org/abs/physics/0207027>); the frequency of  $[C \rightleftharpoons W]$  pulsation is:  $\omega_0 = m_0 c^2 / \hbar$ ; the resulting Compton radius of sub-elementary particle is  $L_0 = \hbar / m_0 c$ .

The resulting external group velocity of particle ( $v$ ) is determined by resulting difference between the actual and complementary masses from (5.20):

$$v_{res} \equiv f(v_{rot}, v_{\parallel tr}, v_{\perp tr}) = c \left[ 1 - \left| \frac{m_C^-}{m_C^+} \right| \right]^{1/2} \quad 5.26a$$

- the translational contribution to the total energy of particle is a sum of longitudinal ( $\parallel tr$ ) and transversal ( $\perp tr$ ) components:

$$(E_{C,W})_{tr} = (E_{C,W})_{\parallel tr} + (E_{C,W})_{\perp tr} \cong (E_{C,W})_{\parallel tr}$$

The resulting **translational** momentum of triplets  $\langle [\mathbf{F}_{\uparrow}^- \bowtie \mathbf{F}_{\uparrow}^+] + \mathbf{F}_{\uparrow}^\pm \rangle$  of particles is:  $p_{\parallel, \perp} = m_C^+ v_{\parallel, \perp} = m_0 v / [1 - (v_{\parallel, \perp}/c)^2]^{1/2}$  is subdivided to longitudinal ( $\parallel$ ) and transversal ( $\perp$ ) ones, as respect to particle external momentum;  $v_{\parallel tr}$  is a longitudinal group velocity of particle's vibrations, induced by oscillation of momentum of uncompensated sub-elementary particle  $\mathbf{F}_{\uparrow}^\pm$ , accompanied its  $[C \rightleftharpoons W]$  pulsation (see 5.30a);  $v_{\perp tr}$  is a transversal group velocity of particle's vibrations, induced by oscillation of resulting momentum of pair  $[\mathbf{F}_{\uparrow}^- \bowtie \mathbf{F}_{\uparrow}^+]$ , accompanied its  $[C \rightleftharpoons W]$  coherent pulsation (see 5.30c).

It is important to note, that:

$$v_{rot} \gg v_{\parallel tr} \gg v_{\perp tr} \quad \text{and} \quad 5.27$$

$$(E_{C,W}^S)_{rot} \gg (E_{C,W})_{\parallel tr} \gg (E_{C,W})_{\perp tr}$$

The set of these expressions, in fact, unify the extended special theory of relativity with quantum mechanics, elucidating the fundamental root of quantum physics: corpuscle - wave duality of particles.

*Our dynamic presentation of duality explains also the elementary particles, as the permanent sources of electromagnetic and gravitational potentials. The source of potential energy is the result of permanent energy redistribution between the negative and positive realms of secondary Bivacuum in a course of  $[C \rightleftharpoons W]$  pulsation of particles, as a mass, electric and magnetic*



dipoles. It is a special kinds of dipole radiation (<http://arXiv.org/abs/physics/0207027>).

The  $\mathbf{F}_{\downarrow}^+$  and  $\mathbf{F}_{\downarrow}^-$  are stable at the equality of their *internal and external* group and phase velocities, corresponding to Golden mean condition, coinciding in turn with condition of resonant virtual energy exchange with Bivacuum in a course of sub-elementary particles [Corpuscle (C)  $\rightleftharpoons$  Wave (W)] pulsation. The **rest mass** of sub-elementary particles (fermions) and their external **charge** are determined by the difference between the actual and complementary mass and between the actual and complementary charges of sub-elementary fermions/antifermions ( $\mathbf{F}_{\downarrow}^+/\mathbf{F}_{\downarrow}^-$ ) at conditions of Golden mean. Corresponding differences are relativist effects, provided by inequality of spinning velocity of the *actual vortex* and *complementary rotor*, forming asymmetric dipoles of  $\mathbf{F}_{\downarrow}^+$  or  $\mathbf{F}_{\downarrow}^-$ . The difference between the actual and complementary energies of  $\mathbf{F}_{\downarrow}^+$  or  $\mathbf{F}_{\downarrow}^-$ , corresponding to Golden mean ( $\phi$ ) conditions, determines the carrying frequency of their [C  $\rightleftharpoons$  W] pulsation:  $[\omega_{C \rightleftharpoons W} = |m_C^+ - m_C^-| \phi c^2 / \hbar = m_0 c^2 / \hbar = \omega_0]^i$ . Sub-elementary particles ( $\mathbf{F}_{\downarrow}^{\pm}$ )<sup>i</sup>, composing particles and matter, like primordial Bivacuum fermions ( $BVF^{\pm}$ )<sup>i</sup>, can be of three modes, corresponding to three lepton generation:  $i = e, \mu, \tau$ .

The square root of product of radiuses of the actual vortex ( $L^+ = \hbar/m_C^+ c$ )<sup>i</sup> and complementary rotor ( $L^- = \hbar/m_C^- c$ )<sup>i</sup> of sub-elementary particles (the resulting radius) is equal to *Compton radius vorticity of the electron* of corresponding generation:  $L_0^i = (L^+ L^-)^{1/2} = \hbar/m_0^i c$ , as far  $[m_C^+ m_C^- = m_0^2]^i$ .

The coherent triplets of two sub-elementary fermions and one sub-elementary antifermion:  $\langle [\mathbf{F}_{\downarrow}^- \times \mathbf{F}_{\downarrow}^+] + \mathbf{F}_{\downarrow}^+ \rangle$  or two sub-elementary antifermion and one sub-elementary fermion:  $\langle [\mathbf{F}_{\downarrow}^+ \times \mathbf{F}_{\downarrow}^-] + \mathbf{F}_{\downarrow}^- \rangle$  represent the electrons and positrons, correspondingly. The absolute values of energy of sub-elementary particles/antiparticles in triplets are equal and determined presumably by energy of *uncompensated*  $[\mathbf{F}_{\downarrow}^{\pm}]$ . Certain combinations of such triplets form quarks and photons. In latter case of elementary bosons, all the properties, except spins, of three sub-elementary particles are compensated by properties of three sub-elementary antiparticles. The in-phase [C  $\rightleftharpoons$  W] pulsation of pairs  $[\mathbf{F}_{\downarrow}^- \times \mathbf{F}_{\downarrow}^+]$  provides the dynamic exchange interaction of elementary particles with Bivacuum and modulation of Bivacuum *virtual pressure waves* (VPW $^{\pm}$ ).

The structure of triplets is stabilized by exchange of virtual clouds of sub-quantum particles between two sub-elementary fermions or antifermions of the opposite spins:  $[\mathbf{F}_{\downarrow}^+]$  and  $\mathbf{F}_{\downarrow}^+$  or  $[\mathbf{F}_{\downarrow}^-]$  and  $\mathbf{F}_{\downarrow}^-$  in a course of their *counterphase* pulsation. Stabilization of pair of sub-elementary fermion and antifermion of mirror symmetry  $[\mathbf{F}_{\downarrow}^- \times \mathbf{F}_{\downarrow}^+]$  or  $[\mathbf{F}_{\downarrow}^+ \times \mathbf{F}_{\downarrow}^-]$ , pulsing in-phase, occur due to minimization of local Bivacuum energy/symmetry shift, reflecting the spatially localized energy conservation. The orientation of sub-elementary particles/antiparticles in triplets is normal to each other.

#### 5.4. New Compensation principle of Bivacuum symmetry shifts, as a new explanation of fields, generated by matter

The law of energy conservation keeps the total energy of [secondary Bivacuum + energy of elementary particles] unchanged and equal to zero. The new compensation principle of Bivacuum symmetry shifts, induced by matter and fields, is a consequence of energy conservation. It can be presented in a following shape:

$$\sum_{n=N} [\mathbf{E}_{\mathbf{S}}^n (F_{\downarrow}^{\pm})^i + \mathbf{E}_{\mathbf{E}}^n (F_{\downarrow}^{\pm})^i + \mathbf{E}_{\mathbf{G}}^n (F_{\downarrow}^{\pm})^i] = \quad 5.28$$

$$= - \sum_{k=\infty} [\Delta \mathbf{E}_{\mathbf{S}(BVF^{\uparrow} \rightleftharpoons BVF^{\downarrow})}^k + \Delta \mathbf{E}_{\mathbf{E}(V^+ \rightleftharpoons V^-)}^k + \Delta \mathbf{E}_{\mathbf{G}(V^+ \rightleftharpoons V^-)}^k] = \quad 5.28a$$

$$= -\beta m_0^i c^2 \frac{\vec{r}}{r} \sum_{k=\infty} \ln [K_{\mathbf{S}(BVF^{\uparrow} \rightleftharpoons BVF^{\downarrow})} K_{\mathbf{E}(V^+ \rightleftharpoons V^-)} K_{\mathbf{G}(V^+ \rightleftharpoons V^-)}]^k \quad 5.29b$$

where:  $N$  is a finite number of elementary particles in closed system under consideration;  
 $k = \infty$  is the infinitive number of asymmetric Bivacuum fermions or antifermions;

The Bivacuum dipoles equilibrium constants we introduce as:

$$K_{S(BVF^\uparrow \rightleftharpoons BVF^\downarrow)^i} = \exp \left[ -\frac{\Delta \mathbf{E}_{S(BVF^\uparrow \rightleftharpoons BVF^\downarrow)^i}^k}{\beta m_0^i c^2} \right] \quad 5.29c$$

$$K_{E(V^+ \rightleftharpoons V^-)^i} = \exp \left[ -\frac{\Delta \mathbf{E}_{E(V^+ \rightleftharpoons V^-)^i}^k}{\beta m_0^i c^2} \right] \quad 5.29d$$

$$K_{G(V^+ \rightleftharpoons V^-)^i} = \exp \left[ -\frac{\Delta \mathbf{E}_{G(V^+ \rightleftharpoons V^-)^i}^k}{\beta m_0^i c^2} \right] \quad 5.29e$$

The local asymmetry, induced by the rest mass, generated by rotation, may be compensated by shift of dynamic equilibrium of Bivacuum fermions with opposite spins  $(BVF^\uparrow \rightleftharpoons BVF^\downarrow)^i$ ; The local asymmetry, induced by local electromagnetic and gravitational potentials may be compensated by equilibrium shifts between properties (mass and charge) of rotors and antirotors  $(V^+ \rightleftharpoons V^-)^i$ , forming  $(BVF^\uparrow$  and  $BVF^\downarrow)^i$ .

**This compensation principle propose a new interpretation of potential fields.**

The basic movement - spinning or rotation, generates uncompensated local charge and rest mass of sub-elementary particles. Compensation of such kind of local asymmetry occur in secondary Bivacuum in form of *spin field*, representing the gradient of equilibrium  $(BVF^\uparrow \rightleftharpoons BVF^\downarrow)^i$  shift, restoring the disturbed spin equilibrium in the Universe, as a sum of two sub-systems [Matter + secondary Bivacuum].

The electromagnetic and gravitational fields are the consequence of Bivacuum fermions/antifermions [rotor  $\rightleftharpoons$  antirotor]  $(V^+ \rightleftharpoons V^-)^i$  dynamic non-local equilibrium shifts, compensating the local shifts, resulting from longitudinal and transverse translational vibrations of elementary particle.

Corresponding fields can be presented as a gradients of corresponding equilibrium constants:

$$\mathbf{E}_{S(BVF^\uparrow \rightleftharpoons BVF^\downarrow)^i}^k = \text{grad} |1 - K_{S(BVF^\uparrow \rightleftharpoons BVF^\downarrow)^i}| \quad 5.29c$$

$$\mathbf{E}_{E(V^+ \rightleftharpoons V^-)^i}^k = \text{grad} |1 - K_{E(V^+ \rightleftharpoons V^-)^i}| \quad 5.29d$$

$$\mathbf{E}_{G(V^+ \rightleftharpoons V^-)^i}^k = \text{grad} |1 - K_{G(V^+ \rightleftharpoons V^-)^i}| \quad 5.29e$$

The periodic *longitudinal* momentum ( $\mathbf{P}_{\parallel tr}$ ), acting on triplets  $\langle [\mathbf{F}_\downarrow^+ \bowtie \mathbf{F}_\uparrow^-] + \mathbf{F}_\uparrow^\pm \rangle$  is provided by periodic [emission - absorption] of cumulative virtual cloud (CVC), followed the  $[C \rightleftharpoons W]$  pulsation of unpaired sub-elementary particle  $\mathbf{F}_\uparrow^\pm$  of triplets. We assume, that the longitudinal ( $z$ ) vibrations of triplets occur in direction, coinciding with the virtual Pointing vector of EM energy density flux, resulting from electric  $[\mathbf{E}]$  and magnetic  $[\mathbf{H}]$  tensions oscillation, accompanied  $[C \rightleftharpoons W]$  pulsation of uncompensated  $\mathbf{F}_\uparrow^\pm$ :

$$\mathbf{P}_{\mathbf{F}_\uparrow^\pm} \equiv \mathbf{P}_{\parallel tr} = [\mathbf{E} \times \mathbf{H}]_{\parallel tr} \quad 5.30$$

Corresponding to (5.30) density of momentum of virtual EM energy is equal to:

$$\mathbf{g}_{\parallel} = \frac{1}{c^2} \mathbf{P}_{\parallel tr} \sim \alpha [m_C^+ - m_C^-] c \sim \alpha m_C^+ v^2 / c = \alpha \frac{\mathbf{P}^2}{m_C^+ c} \quad 5.30a$$

where  $\alpha = e^2 / \hbar c$  is the electromagnetic (EM) fine structure constant.

The periodic transversal momentum, acting on elementary particles, is provided by periodic [emission - absorption] of cumulative virtual cloud (CVC), followed the  $[C \rightleftharpoons W]$  pulsation of paired sub-elementary particle  $[\mathbf{F}_\downarrow^+ \bowtie \mathbf{F}_\uparrow^-]$  of triplets  $\langle [\mathbf{F}_\downarrow^+ \bowtie \mathbf{F}_\uparrow^-] + \mathbf{F}_\uparrow^\pm \rangle$ . Its direction coincides with resulting virtual Pointing vector, generated by in-phase pulsation of quasisymmetric  $\mathbf{F}_\downarrow^+$  and  $\mathbf{F}_\uparrow^-$ , which is equal to difference between Pointing vectors of each of these sub-elementary

particle and sub-elementary antiparticle:

$$\mathbf{P}_{\mathbf{F}_{\uparrow}^{\dagger} \bowtie \mathbf{F}_{\downarrow}^{\dagger}} \equiv \mathbf{P}_{\perp tr} = \mathbf{P}_{\mathbf{F}_{\uparrow}^{\dagger}} - \mathbf{P}_{\mathbf{F}_{\downarrow}^{\dagger}} = [\mathbf{E} \times \mathbf{H}]_{\mathbf{P}_{\mathbf{F}_{\uparrow}^{\dagger}}} - [\mathbf{E} \times \mathbf{H}]_{\mathbf{P}_{\mathbf{F}_{\downarrow}^{\dagger}}} \quad 5.30b$$

Corresponding to (5.30b) density of transversal momentum of virtual EM energy, radiated by pair  $[\mathbf{F}_{\uparrow}^{\dagger} \bowtie \mathbf{F}_{\downarrow}^{\dagger}]$  is equal to:

$$\mathbf{g}_{\perp} = \frac{1}{c^2} \mathbf{P}_{\perp tr} \sim [m_C^+ - m_C^-]_{\mathbf{F}_{\uparrow}^{\dagger}} c - [m_C^+ - m_C^-]_{\mathbf{F}_{\downarrow}^{\dagger}} c \sim \beta m_C^+ v^2 / c = \beta \frac{\mathbf{P}^2}{m_C^+ c} \quad 5.30c$$

where  $\beta = (m_0/M_{Pl})^2$  is the gravitational fine structure constant.<sup>17</sup>

The virtual photons emission, responsible for virtual Pointing vector, in accordance with known theory of the electric and magnetic dipole radiation, is a result of electric and magnetic charges acceleration in a course of  $[C \rightleftharpoons W]$  pulsation of sub-elementary particles/antiparticles composing elementary particles.

Sub-elementary particles represent asymmetric triple-dipoles: electric, magnetic and mass dipoles (section 5.1) in contrast to 'almost' symmetric Bivacuum fermions and antifermions, as a pairs [rotor + antirotor]. The energy source of  $[C \rightleftharpoons W]$  pulsations and radiation is a quantum beats between positive and negative nonequilibrium sublevels of Bivacuum (Kaivarainen, 2002).<sup>17</sup>

The non-local  $(V^+ \rightleftharpoons V^-)_{E,el}^i$  and  $(V^+ \rightleftharpoons V^-)_{H,G}^i$  equilibrium shifts in Bivacuum, compensating the local shifts, occurs around the electron or other lepton, as a result of interaction of opposite charge and magnetic moments of  $V^+$  and  $V^-$  (see section 5.1), forming Bivacuum double dipoles  $(BVF^{\uparrow} \text{ and } BVF^{\downarrow})^i$  with virtual dipole radiation of elementary particles.

The part (5.28a) represents the sum of three contributions of *localized* Bivacuum dipoles symmetry shift, induced by rotation (spinning) and two kinds of translational vibrations responsible for electromagnetic and gravitational potentials. *The rotational energy contribution*, responsible for mass of rest ( $m_0$ ) and charge ( $e_0$ ) origination, satisfies the Golden mean conditions, due to resonant exchange interaction of each lepton generation ( $i = e, \mu, \tau$ ) with Bivacuum virtual pressure waves (VPW $^{\pm}$ ):

$$\Delta m_C^{\phi} = |m_C^+ - m_C^-|^{\phi} = m_0 = \phi(m_C^+)^{\phi} \quad 5.31$$

$$\Delta e^{\phi} = |e_+ - e_-|^{\phi} = e_0 = \phi e \quad 5.31a$$

where the resulting *internal* charge from 5.22a is equal to:  $e = \sqrt{|e_+ e_-|}$

The rotational contribution, which creates the rest mass and spin potential, can be presented for corpuscular [C] and wave [W] phase, as follows (<http://arXiv.org/abs/physics/0207027>):

$$\mathbf{E}_{\mathbf{S}}^n(F_{\uparrow}^{\pm})_{[C]}^i = \left( [m_C^+ v_{rot}^2]^{\phi} = [m_C^+]^{\phi} (\phi c)^2_{rot} = \frac{\hbar^2}{[m_C^+ (L_C^+)^2]^{\phi}} = \hbar \omega_{C \rightleftharpoons W}^{\phi} \right)_{[C]}^i \quad 5.32$$

$$\mathbf{E}_{\mathbf{S}}^n(F_{\uparrow}^{\pm})_{[W]}^i = \left( |m_C^+ - m_C^-|^{\phi} c^2 = m_0 c^2 = \frac{\hbar^2}{m_0 L_0^2} = m_0 \omega_0^2 L_0^2 = \hbar \omega_0 \right)_{[W]}^i \quad 5.32a$$

where the Golden mean angle frequency is  $\omega_0 = m_0 c^2 / \hbar$ ; the corresponding Compton radius  $L_0 = \hbar / m_0 c$  and  $\mathbf{E}_{\mathbf{S}}^n(F_{\uparrow}^{\pm})_{[C]}^i = \mathbf{E}_{\mathbf{S}}^n(F_{\uparrow}^{\pm})_{[W]}^i$

*The energy contribution of longitudinal oscillation*, induced by  $[C \rightleftharpoons W]$  pulsation of uncompensated sub-elementary particles  $F_{\uparrow}^{\pm}$  > of triplets  $\langle [F_{\downarrow}^- \bowtie F_{\uparrow}^+] + F_{\uparrow}^{\pm} \rangle$ , is responsible for electric potential of elementary particles. At Golden mean conditions it can be presented for [C] and [W] phase as (<http://arXiv.org/abs/physics/0207027>):

$$\mathbf{E}_{\mathbf{E}}^n(F_{\uparrow}^{\pm})_{[C]}^i = \left[ \alpha [m_C^+ v_{res}^2]^\phi = \alpha \left[ \frac{\mathbf{p}^2}{m_C^+} \right]^\phi = [m_C^+ v_{\parallel tr}^2]^\phi = (zc)^2 [m_C^+]^\phi = \alpha \phi [m_C^+]^\phi c^2 \right]_{[C]}^i \quad 5.33$$

$$\mathbf{E}_{\mathbf{E}}^n(F_{\uparrow}^{\pm})_{[W]}^i = \left[ \left( \frac{e_+ e_-}{L^\pm} \right)^\phi = \alpha (m_C^+ - m_C^-)^\phi c^2 = \alpha m_0 c^2 \right]_{[W]}^i \quad 5.33a$$

where:  $v_{res}$  is the resulting rotational-translational velocity of sub-elementary fermion (5.26a);  $v_{\parallel tr}^\phi = zc$  is a velocity of longitudinal translational zero-point vibrations;  $z = (\alpha\phi)^{1/2}$  is a longitudinal zero-point factor;  $\alpha = e^2/\hbar c$  is the electromagnetic fine structure constant;  $L^\pm = \hbar/(m_C^+ - m_C^-)^\phi c = L_0$  is a characteristic dimension of asymmetric double cell-dipole separating the actual ( $e_+$ ) and complementary ( $e_-$ ) charge of each of three sub-elementary particles of the electron or positron  $\langle [F_{\uparrow}^- \bowtie F_{\uparrow}^+] + F_{\uparrow}^\pm \rangle$ .

The energy contribution of transversal oscillation of triplets  $\langle [F_{\uparrow}^- \bowtie F_{\uparrow}^+] + F_{\uparrow}^\pm \rangle$ , induced by  $[C \Leftrightarrow W]$  pulsation of pairs  $[F_{\uparrow}^- \bowtie F_{\uparrow}^+]$ , is responsible for gravitational potential of elementary particles. At Golden mean conditions it can be presented as:

$$\mathbf{E}_{\mathbf{G}}^n(F_{\uparrow}^{\pm})_{[C]}^i = \left[ \beta [m_C^+ v_{res}^2]^\phi = \beta \left[ \frac{\mathbf{p}^2}{m_C^+} \right]^\phi = [m_C^+ v_{\perp tr}^2]^\phi = (xc)^2 [m_C^+]^\phi = \beta \phi [m_C^+]^\phi c^2 \right]_{[C]}^i \quad 5.34$$

$$\mathbf{E}_{\mathbf{G}}^n(F_{\uparrow}^{\pm})_{[W]}^i = \left[ G \left( \frac{m_C^+ m_C^-}{L^\pm} \right)^\phi = \beta (m_C^+ - m_C^-)^\phi c^2 = \beta m_0 c^2 = \Delta m_V^\phi c^2 \right]_{[W]}^i \quad 5.34a$$

where:  $v_{res}$  is the resulting rotational-translational velocity of sub-elementary fermion (5.26a);  $v_{\perp tr} = xc$  is a velocity of transversal translational zero-point vibrations, responsible for gravitation;  $x = (\beta\phi)^{1/2}$  is a transversal zero-point factor.

The longitudinal and transversal velocities of elementary particle and corresponding factors at Golden mean conditions are summarized below:

$$v_{\parallel tr}^\phi = zc \quad \text{where :} \quad z = (\alpha\phi)^{1/2} \quad 5.34b$$

$$v_{\perp tr} = xc \quad \text{where :} \quad x = (\beta\phi)^{1/2} \quad 5.34c$$

These minimum values corresponds to zero-point oscillations of particles.

At conditions of Golden mean:  $|m_C^+ - m_C^-|^\phi = m_0$ , the curvature, corresponding to spinning (rotation) of sub-elementary particles, turns to that, equal to Compton radius:

$$(L_{C,W}^{rot})^\phi = \frac{\hbar}{|m_C^+ - m_C^-|^\phi c} = \frac{\hbar}{m_0 c} \equiv L_0 \quad 5.35$$

It follows from our theory, that shift of symmetry between properties of rotors ( $V^+$ ) and antirotors ( $V^-$ ), forming  $BVF^\uparrow \sim [V^+ + V^-]$  is accompanied by creation of difference between the actual and complementary mass:  $|m_C^+ - m_C^-| > 0$  and the actual and complementary charge:  $|e_+ - e_-| > 0$ . This shift in Bivacuum dipoles ( $BVF^\uparrow$ ) is much less, than the mass and charge shifts in stable sub-elementary particles  $F_{\uparrow}^\pm$ . However, in accordance to formula (5.20), even small decreasing of ratio  $|m_C^-/m_C^+|_{BVF^\uparrow} < 1$  means that the external translational velocity of  $BVF^\uparrow$  becomes more, than zero ( $v_{ext} \equiv v = c \left[ 1 - \left| \frac{m_C^-}{m_C^+} \right|_{BVF^\uparrow} \right]^{1/2} > 0$ ), as well as their momentum ( $p_{BVF}^i = m_{BVF}^i v_{ext}$ )  $> 0$ . Correspondingly, the external virtual wave B length of  $BVF^\uparrow$  becomes less, than infinity:

$$L_{BVF}^i = \frac{\hbar}{m_{BVF}^i v_{ext}} = \frac{\hbar}{m_{BVF}^i c \left[ 1 - \left| \frac{m_C^-}{m_C^+} \right|_{BVF^\uparrow} \right]^{1/2}} < \infty \quad 5.35a$$

In turn, this means that condition of infinitive virtual Bose condensation (VirBC), pertinent for primordial Bivacuum, is violated (Kaivarainen, <http://arXiv.org/abs/physics/0207027>)<sup>17</sup> and

nonlocality remains possible only in domains of secondary Bivacuum with radius, with dimensions determined by (5.35a).

**The curvature of Bivacuum**, corresponding to symmetry shift, related to *longitudinal* zero-point vibrations of elementary particles, which determines the electric potential, can be found from:

$$E_E = \alpha |m_C^+ - m_C^-| c^2 = \alpha \frac{\hbar c}{L_0} \quad 5.36$$

The corresponding to electric potential space curvature at Golden mean conditions  $|m_C^+ - m_C^-|^\phi = m_0$ , is equal to radius of  $E$  – domains nonlocality  $(L_{BVF}^i)_E$ :

$$L_E^\phi = \frac{1}{\alpha} \frac{\hbar}{m_0 c} = \frac{1}{\alpha} L_0 = \frac{\hbar}{m_C^\pm v_{\parallel tr}} = (L_{BVF}^i)_E \quad 5.37$$

From (5.37) we can see, that the curvature radius, corresponding to EM potential of particle exceeds its Compton radius to about 137 times:

$$\frac{L_{EM}^\phi}{L_0} = \frac{1}{\alpha} \sim 137 \quad 5.38$$

In similar way, the curvature of Bivacuum, related to *transversal* zero-point vibrations of elementary particles, which determines radius of gravitational domains of nonlocality:

$$L_G^\phi = \frac{1}{\beta} \frac{\hbar}{m_0 c} \quad 5.39$$

The gravitational curvature radius of Bivacuum symmetry compensation exceeds the Compton radius of the electron to  $10^{45}$  times:

$$\frac{L_G^\phi}{L_0} = \frac{1}{\beta} = \left( \frac{M_{Pl}}{m_0} \right)^2 \sim 10^{45} \quad 5.40$$

$$or : L_G^\phi \sim 10^{45} L_0 \quad 5.41$$

The electromagnetic and gravitational interaction energy between two particles (1) and (2) can be presented as the square root of product of particles corresponding potentials:

$$\mathbf{E}_E^{1,2} = [\mathbf{E}_E^{(1)} \mathbf{E}_E^{(2)}]^{1/2} \quad 5.42$$

$$\mathbf{E}_G^{1,2} = [\mathbf{E}_G^{(1)} \mathbf{E}_G^{(2)}]^{1/2} \quad 5.42a$$

### 5.5 Neutrino and Antineutrino in Unified Model

We put forward a conjecture, that neutrino or antineutrino of three lepton generation, represents a stable non-local Bivacuum symmetry excitations, compensating the local symmetry violation, accompanied the creation of the electron's or positron's and their transversal zero-point vibrations. The energy of neutrinos and antineutrinos are related to the rest mass of corresponding generations of the electron and positron ( $\pm m_0^{e,\mu,\tau}$ ) in following manner (see 5.34):

$$E_{e,\mu,\tau}^{v,\bar{v}} = [m_C^+ v_{\parallel tr}^2]_{e,\mu,\tau}^{v,\bar{v}} = \pm \beta_{e,\mu,\tau} (m_0^{e,\mu,\tau}) c^2 \left( \frac{1}{2} + n \right) = \pm \Delta (m_V^{e,\mu,\tau}) c^2 \left( \frac{1}{2} + n \right) \quad 5.43$$

where  $(\pm m_0^{e,\mu,\tau})$  are the rest mass of  $[e, \mu, \tau]$  generations of electrons and positrons;  $\beta_{e,\mu,\tau} = (m_0^{e,\mu,\tau} / M_{Pl})^2$  is a gravitational fine structure constants, introduced in our theory of gravitation (<http://arXiv.org/abs/physics/0207027>);  $\pm \Delta (m_V^{e,\mu,\tau}) c^2 = \pm \beta_{e,\mu,\tau} (m_0^{e,\mu,\tau}) c^2$  are the Bivacuum symmetry stable ground shifts, corresponding to three neutrino flavors at Golden mean conditions.

The charge of neutrino, from (5.31a) is very close to zero:

$$e_\nu = \pm \beta_{e,\mu,\tau} e_0 \cong 0 \quad 5.43a$$

The evidence of neutrino flavor oscillation:  $e \rightleftharpoons \mu \rightleftharpoons \tau$  has been recently obtained in Sudbury Neutrino Observatory (SNO, 2002). This means possibility of collective quantum transitions between symmetry shifts of secondary Bivacuum:  $\Delta(m_{\nu}^e) \rightleftharpoons \Delta(m_{\nu}^\mu) \rightleftharpoons \Delta(m_{\nu}^\tau)$ , as a result of interconversions between three basic generation of cell-dipoles  $(BVF^\pm)^i$  with three corresponding resulting mass:  $(m_0^e) \rightleftharpoons (m_0^\mu) \rightleftharpoons (m_0^\tau)$ , where  $m_0^i = \sqrt{(m_C^+ m_C^-)^i}$ .

It is known, that neutrinos ( $\nu_e; \nu_\mu; \nu_\tau$ ) always originates in pairs with antileptons ( $e^+; \mu^+; \tau^+$ ) and antineutrinos ( $\bar{\nu}_e; \bar{\nu}_\mu; \bar{\nu}_\tau$ ) in pairs with leptons ( $e^-; \mu^-; \tau^-$ ). Neutrino and antineutrino may be considered, as collective excitations of huge domains of Bivacuum in state of virtual Bose condensation (VirBC). The characteristic radius of such excited state, characterizing the neutrino curvature is equal to:

$$L_{\nu_{e,\mu,\tau}}^{(n)} = \frac{\hbar}{[\beta m_0]_{e,\mu,\tau} (\frac{1}{2} + n)} \quad 5.44a$$

Obviously the neutrino/antineutrino directly participate in gravitational interaction/repulsion. The energy of such interaction should be dependent on density energy of neutrino and its generation.

#### 5.6 Harmonization energy and force of Bivacuum, as background of Principle of least action

It is shown, that Principle of least action is a consequence of introduced in UM "Harmonization energy (HaE)" of asymmetric Bivacuum, driving the matter to Golden Mean conditions and responsible for its evolution on all hierarchic levels (Kaivarainen, 2002). We introduce the Harmonization energy  $(HaE)^i$  of Bivacuum, acting on three generations ( $i = e, \mu, \tau$ ) of elementary particles of matter, as a difference between their total energy and the basic energy of virtual pressure waves of Bivacuum  $(VPW^\pm)^i$ , equal to:  $E_{VPW^\pm}^i = \hbar \omega_0^i = m_0^i c^2$

$$E_{HaE}^i = |E_{C \rightleftharpoons W} - E_{VPW^\pm}^i|^i = |m_C^+ (v_{gr}^{ext})^2 - m_0 c^2|^i = \hbar |\omega_{C \rightleftharpoons W} - \omega_0|^i \quad 5.44$$

Taking into account the expressions for total energy of elementary particle, eq.(5.44) can be transformed (see 5.24-5.24c and 5.33-5.34) to:

$$E_{HaE}^i = (E_{C,W})_{\parallel tr} + (E_{C,W})_{\perp tr}]^i = (E_{el} + E_G)^i = \quad 5.45a$$

$$= |m_C^+ - m_C^-|_{\parallel tr} c^2 + |m_C^+ - m_C^-|_{\perp tr} c^2 = |m_C^+ v^2|_{\parallel tr}^i + |m_C^+ v^2|_{\perp tr}^i = \quad 5.45b$$

$$= m_0^i c^2 \frac{(v_{\parallel}/c)^2}{[1 - (v_{\parallel}/c)^2]^{1/2}} + m_0^i c^2 \frac{(v_{\perp}/c)^2}{[1 - (v_{\perp}/c)^2]^{1/2}} \quad 5.45c$$

#### Bivacuum HaE, as a Background of Principle of Least Action

The directed influence of Bivacuum Harmonization Energy on frequency of  $[C \rightleftharpoons W]$  pulsation and other kind of dynamics of elementary particles, atoms and molecules - could be a physical background of *Principle of Least Action*. The *Action* in Lagrange form for any elementary particle, taking into account (5.44 and 5,45a) can be presented as:

$$[S = S^{ext} - S^{in} = |m_C^+ (v_{gr}^{ext})^2 - m_0 c^2| t = E_{HaE}^i t]^i \quad 5.46$$

The Principle of least action, demanding that variation of action should be minimum:

$$\delta S = 0 \text{ means that } [\delta E_{HaE}^i t + E_{HaE}^i \delta t]^i = 0 \quad 5.47$$

or, using (5.45) we come to:

$$\left[ \frac{\delta t}{t} \right]^i = -\frac{\delta E_{HaE}^i}{E_{HaE}^i} = -\frac{\delta(E_{el} + E_G)^i}{(E_{el} + E_G)^i} = -\frac{\delta[(T_k)_{\parallel tr} + (T_k)_{\perp tr}]^i}{[(T_k)_{\parallel tr} + (T_k)_{\perp tr}]^i} \quad 5.48$$

This formula interrelates the pace of time for free particle or closed system of leptons of three generations ( $i = e, \mu, \tau$ ) with pace of kinetic energy contributions changes, irresponsible electromagnetic and gravitational potentials of these particles.

In general logarithmic form the formula for Superunification (5.48) turns to:

$$d \ln t = -d \ln E_{HaE} = -d \ln(E_{el} + E_G) = -d \ln[(T_k)_{\parallel tr} + (T_k)_{\perp tr}] \quad 5.48a$$

If we consider the system of  $N$  interacting particles at the permanent time period ( $t = T = 1/\nu = const$ ), when  $\delta t = \delta T = 0$ , then the principle of least action for such system, leading from (5.47 and 5.45), can be presented as:

$$\sum_k^N (\delta E_{HaE}^i)_k T = \frac{1}{\nu} \sum_k^N (\delta E_{HaE}^i)_k = 0 \quad \text{at :} \quad t = 1/\nu = const > 0 \quad 5.49$$

$$\text{or :} \sum_k^N (\delta E_{HaE}^i)_k = \sum_k^N \delta[E_{el} + E_G]^i = \sum_k^N \delta \left[ |m_C^+ v^2|_{\parallel tr}^i + |m_C^+ v^2|_{\perp tr}^i \right]^i = 0 \quad 5.49a$$

Except Harmonization energy of Bivacuum (HaE - 5.45a), we may introduce also the Harmonization force of Bivacuum, acting on internal and external dynamics of elementary particles and atoms, like time derivative of Harmonization energy momentum ( $F_{HaF} = \partial p_{HaE} / \partial t$ ), where  $p_{HaE} = E_{HaE} / c$ . From (5.49) we find:

$$F_{HaF} = \partial p_{HaE} / \partial t = \frac{\partial}{\partial t} \left[ |m_C^+ - m_C^-|_{\parallel tr} c + |m_C^+ - m_C^-|_{\perp tr} \right] c = \quad 5.50$$

$$= \frac{\partial}{\partial t} \left[ \alpha / c |m_C^+ v^2|^i + \beta / c |m_C^+ v^2|^i \right] = \frac{\partial}{\partial t} [E_{el}^i + E_G^i] \quad 5.51$$

This expression means, that HaF of Bivacuum, acting on matter, is a result of Bivacuum *feedback reaction*, determined by time-dependent change of electromagnetic and gravitational fields, radiated by matter.

#### *Experimental evidence in proof of Unified Model (UM)*

The formulae 5.33 and 5.34 for electromagnetic and gravitational potentials in general case (not just for Golden mean conditions) can be presented as:

$$\mathbf{E}_{\mathbb{E}}^n (F_{\uparrow}^{\pm})_{[C]}^i = \alpha [m_C^+ \mathbf{v}_{res}^2] = \alpha \frac{\mathbf{p}^2}{m_C^+} \quad 5.52$$

$$\mathbf{E}_{\mathbb{G}}^n (F_{\uparrow}^{\pm})_{[C]}^i = \beta [m_C^+ \mathbf{v}_{res}^2] = \beta \frac{\mathbf{p}^2}{m_C^+} \quad 5.52a$$

It follows from our expressions, that the charged particle, accelerating permanently (like in cyclotron or synchrotron) or alternatively, like in undulator, should be a source of photons and gravitational waves:

$$\hbar \omega_p = \left[ \mathbf{E}_{\mathbb{E}}^n (F_{\uparrow}^{\pm})_{[C]}^i \right]_{t+\Delta t} - \left[ \mathbf{E}_{\mathbb{E}}^n (F_{\uparrow}^{\pm})_{[C]}^i \right]_t = \alpha \left[ (m_C^+ \mathbf{v}_{res}^2)_{t+\Delta t} - (m_C^+ \mathbf{v}_{res}^2)_t \right] \quad 5.53$$

$$\hbar \omega_G = \left[ \mathbf{E}_{\mathbb{G}}^n (F_{\uparrow}^{\pm})_{[C]}^i \right]_{t+\Delta t} - \left[ \mathbf{E}_{\mathbb{G}}^n (F_{\uparrow}^{\pm})_{[C]}^i \right]_t = \beta \left[ (m_C^+ \mathbf{v}_{res}^2)_{t+\Delta t} - (m_C^+ \mathbf{v}_{res}^2)_t \right] \quad 5.53a$$

The are huge number of experimental data, confirming this consequence of presented theory for electromagnetic radiation. The gravitational radiation in similar conditions is also predictable by our Unified Model (UM).

For the case of cyclotron radiation, the photons are result of transition between quantum Landau levels:

$$E_n = \hbar\omega_p = (n + 1/2)\hbar\omega_c \quad n = 1, 2, 3, \dots \quad 5.54$$

where the cyclotron frequency of the electrons rotation in plane, normal to magnetic field  $\mathbf{H}$  is

$$\omega_c = \frac{e\mathbf{H}}{m_c^+c} \quad 5.55$$

*The other consequence of UM* is that this kinds of radiation should be strongly asymmetric, coinciding mostly with direction of particle propagation in space. It is also well supported especially by experimental analysis of synchrotron and undulator radiation.

Most of energy, emitted by relativist particle is located in direction, close to its instant velocity ( $v = v_{ext} \rightarrow c$ ) in narrow angles range, determined by semiempirical expression (Ginsburg, 1987):

$$\Delta\theta \simeq [1 - (v/c)^2]^{1/2} = \frac{m_0c^2}{E} \ll 1 \quad 5.56$$

where:  $E$  is a total relativist energy of the charged particle.

Our theory leads to same result. Formula (5.20) for relativist condition ( $v \rightarrow c$ ), taking into account (5.18a), can be presented as:

$$[1 - (v/c)^2]^{1/2} = \left| \frac{m_c^-}{m_c^+} \right|^{1/2} = \frac{m_0c^2}{m_c^+c^2} = \frac{S^+}{S^-} \quad 5.57$$

where  $S^+$  and  $S^-$  are the cross section of the actual vortex and complementary rotor of sub-elementary particles (see 5.10).

As far, in accordance to our approach, the actual energy of particle is  $E = m_c^+c^2$ , we can see that 5.56 coincides with 5.57.

In some special conditions, the undulator radiation is highly monochromatic and polarized. Synchrotron radiation also is polarized. The electric vector of radiated photons is in the same plane, as direction of acceleration of particles. As far the direction of acceleration of charged particle in magnetic field change all the time, the photons have the elliptic polarization.

Our notion of Bivacuum (B), as a quantum liquid, composed from sub-quantum particles and their corrective excitations [rotors + antirotors], representing symmetric (primordial B) or quasisymmetric (secondary B) mass - dipoles, electric charge - dipoles and magnetic charge - dipoles, is in accordance with experimental behavior of vacuum in strong electromagnetic field, as anisotropic medium with double refractive properties. For example, the refraction index of vacuum is dependent on polarization of photons in strong magnetic field, shifting spin equilibrium:  $[BVF^\uparrow \rightleftharpoons BVF^\downarrow]$  normal or in-line with magnetic field tension. Such effects can be analyzed in terms of nonlinear properties of vacuum (Ginsburg, 1987).

## 6 Possible mechanism of entanglement between elementary particles, complex systems, & Mind-Matter and Mind-Mind Interaction

### 6.1 Quantum entanglement between coherent elementary particles

In accordance to our UM, the *nonlocal* interaction (quantum entanglement) between particles with coherent  $[C \rightleftharpoons W]$  pulsation is realized via Bivacuum symmetry oscillation (BvSO), modulated the exchange interaction between virtual pressure waves (VPW $^\pm$ ) of Bivacuum and symmetric pairs  $[\mathbf{F}_\downarrow^- \bowtie \mathbf{F}_\uparrow^+]$  of elementary particles  $\langle [\mathbf{F}_\downarrow^- \bowtie \mathbf{F}_\uparrow^+] + \mathbf{F}_\uparrow^\pm \rangle$  in a course of  $[C \rightleftharpoons W]$  pulsation of pairs. Experimentally, the quantum entanglement was revealed firstly by Aspect, et al., (1982; 1983).



Such a process is mediated by nonlocal BvSW in the volume of virtual Bose condensate (VirBC), formed by  $BVF^\dagger$  and  $BVB^\pm$  with external momentum, close to zero (see section 1).

The nonlocal Bivacuum symmetry waves (**BvSW**) $^{\parallel,\perp}$  are excited by BvSO $^{\parallel,\perp}$ . In turn, BvSO $^{\parallel,\perp}$  can be subdivided to longitudinal ( $\parallel$ ), related to electromagnetism and transversal ( $\perp$ ), related to gravitation. They are a consequence of oscillation between different Bivacuum symmetry shifts, corresponding to [C] and [W] phase of unpaired  $\mathbf{F}_\dagger^\pm$  and pair  $[\mathbf{F}_\dagger^- \bowtie \mathbf{F}_\dagger^+]$  of triplets of sub-elementary particles. Their values are correspondingly:

$$\left[ (\Delta m_V^{[C]})_{\mathbf{F}_\dagger^\pm} = \alpha(m_C^+ - m_C^-) = \alpha m_C^+ (v/c)^2 = \frac{\alpha}{c^2} \hbar \omega_{C \rightleftharpoons W} \right]_{x,y,z}^{\parallel} \quad 6.1$$

$$\text{and } \left[ (\Delta m_V^{[C]})_{\mathbf{F}_\dagger^- \bowtie \mathbf{F}_\dagger^+} = \beta(m_C^+ - m_C^-) = \beta m_C^+ (v/c)^2 = \frac{\beta}{c^2} \hbar \omega_{C \rightleftharpoons W} \right]_{x,y,z}^{\perp} \quad 6.2a$$

$$\Delta m_V^{[W]} \cong 0, \quad \text{as far in [W] phase : } m_C^+ \cong m_C^-$$

The Bivacuum dipoles symmetry shift, related to [W] phase, can be exactly equal to zero  $\Delta m_V^{[W]} = 0$  only in primordial vacuum. Consequently, [C  $\rightleftharpoons$  W] pulsation of uncompensated sub-elementary particle and quasisymmetric pair of each elementary particle is accompanied by BvSO with the same frequency ( $\omega_{BvSO} = \omega_{C \rightleftharpoons W}$ ):

$$[\omega_{BvSO} = \omega_{C \rightleftharpoons W} = (m_C^+ - m_C^-)c^2/\hbar]^{\parallel,\perp} \quad 6.3$$

the amplitudes of BvSO, generated by pulsation of unpaired  $\mathbf{F}_\dagger^\pm$  and pair  $[\mathbf{F}_\dagger^- \bowtie \mathbf{F}_\dagger^+]$ , correspondingly, are equal, to:

$$\left[ \Delta \Delta m_{\parallel}^{C \rightleftharpoons W} = \Delta m_{\parallel}^{[C]} - \Delta m_{\parallel}^{[W]} = \alpha m_C^+ (v/c)^2 = \frac{\alpha}{c^2} \frac{(P^{ext})^2}{m_C^+} \right]_{\mathbf{F}_\dagger^\pm}^{\parallel} \quad 6.4$$

$$\text{and } \left[ \Delta \Delta m_{\perp}^{C \rightleftharpoons W} = \Delta m_{\perp}^{[C]} - \Delta m_{\perp}^{[W]} = \beta m_C^+ (v/c)^2 = \frac{\beta}{c^2} \frac{(P^{ext})^2}{m_C^+} \right]_{[\mathbf{F}_\dagger^- \bowtie \mathbf{F}_\dagger^+]}^{\perp} \quad 6.4a$$

where:  $L = \hbar/P^{ext}$  is a actual de Broglie wave of particle;  $P^{ext} = m_C^+ v$  is the external momentum of particle.

The anisotropic amplitude probability of resonant exchange interaction between **two** particles: 'sender (S)' and 'receiver (R)' ( $A_{C \rightleftharpoons W}$ ) $_{x,y,z}$  may be qualitatively described, using well known model of **damped harmonic oscillator** interacting with external alternating field:

$$[A_{C \rightleftharpoons W}]_{x,y,z}^{\parallel,\perp} \sim \left[ \frac{1}{(m_C^+)_R} \frac{[F_{BvSO}]_{x,y,z}}{\omega_R^2 - \omega_S^2 + \text{Im } \gamma \omega_S} \right]_{x,y,z}^{\parallel,\perp} \quad 6.5$$

where:  $\omega_R$  and  $\omega_S$  are the frequencies of C  $\rightleftharpoons$  W pulsation of sub-elementary particles of (S) and (R);

$\gamma$  is a damping coefficient due to exchange interaction of pairs  $[\mathbf{F}_\dagger^- \bowtie \mathbf{F}_\dagger^+]$  of triplets  $\langle [\mathbf{F}_\dagger^- \bowtie \mathbf{F}_\dagger^+] + \mathbf{F}_\dagger^\pm \rangle$  by means of virtual pressure waves (VPW $^\pm$ ) with Bivacuum. This interaction may induce decoherence in (S) and (R) pulsations due to deviation of  $\omega_R$  and  $\omega_S$  from the Golden mean frequency  $\omega_0$ , being a fundamental frequency of Bivacuum. The local Bivacuum fluctuations nearby [R] or [S] also may be responsible for decoherence and damping of the particles entanglement;  $(m_C^+)_R$  is the actual mass of (R).

$[F_{BvSO}]_{x,y,z}$  is a spatially anisotropic *force of Bivacuum symmetry oscillation*, related to energy of these asymmetric oscillation ( $\Delta \Delta m_V^{C \rightleftharpoons W} c^2$ ) with radius of action ( $L_{BvSO}$ ) $_{x,y,z}$  of BvSO, induced by C  $\rightleftharpoons$  W pulsation of one elementary particle:

$$\left[ F_{BvSO} \sim \frac{\Delta \Delta m_V^{C \rightleftharpoons W} c^2}{L_{BvSO}} = \frac{1}{\hbar} (\Delta \Delta m_V^{C \rightleftharpoons W})^2 c^3 \right]_{x,y,z}^{\parallel,\perp} \quad 6.6$$

where radius of BvSO ( $L_{BvSO}$ ), equal to radius of nonlocality ( $L_{NL}$ ), generated by N particles, is related directly to Bivacuum dipoles symmetry shift around the system of interacting particles ( $\Delta\Delta m_{V^{C\rightleftharpoons W}}$ ):

$$\left[ L_{BvSO} = L_{NL} = \frac{\hbar}{\Delta\Delta m_{V^{C\rightleftharpoons W}c}} \right]_{x,y,z}^{\parallel,\perp} \quad 6.7$$

$$\text{where : } (\Delta\Delta m_{V^{C\rightleftharpoons W}c})_{\mathbf{F}_{\mp}^{\pm}}^{\parallel} = \alpha [m_C^{\pm}(v/c)_i^2]_{x,y,z}^{\parallel} \quad 6.8$$

$$(\Delta\Delta m_{V^{C\rightleftharpoons W}c})_{\mathbf{F}_{\mp}^{\pm}\otimes\mathbf{F}_{\mp}^{\pm}}^{\perp} = \beta [m_C^{\pm}(v/c)_i^2]_{x,y,z}^{\perp} \quad 6.8a$$

The effectiveness of nonlocal interaction between two separated elementary particles is dependent on synchronization of  $[C \rightleftharpoons W]$  pulsations, and correlation of polarization of  $(VPW^{\pm})_{x,y,z}$  of Bivacuum in the system of interacting particles. The bigger is Bivacuum dipoles symmetry shift ( $\Delta\Delta m_{V^{C\rightleftharpoons W}}$ ), induced by sender (S) and the more coherent are  $C \rightleftharpoons W$  pulsation of (S) and receiver (R), the less is frequency deviation  $\Delta\omega = \omega_R - \omega_S$  and the more effective is quantum entanglement between particles.

The mechanism, proposed, may explain the theoretical (Einstein, et all. 1935; Cramer, 2001) and experimental evidence in proof of nonlocal interaction between coherent elementary particles (Aspect, et all. 1982; 1983) and atoms.

*Our theory predicts, that the same mechanism may provide the distant quantum entanglement between mesoscopic and macroscopic systems, including biological ones, if  $[C \rightleftharpoons W]$  pulsations of their particles are 'tuned' to each other and they have close spatial polarization and symmetry. (Kaivarainen, 2001d).*

### 6.2. The mechanism of quantum entanglement between complex systems

Let us analyze the possible mechanism of quantum entanglement between complex systems in the framework of our Unified model. If we apply the principle of least action in form of (5.49a) to interaction of sender [S] and receiver [R], the N interacting particles of these two subsystems can be subdivided as:

$$N = N_S + N_R \quad 6.9$$

For this case (5.49a) represents a sum of two opposite by sign contributions:

$$\sum_k^{N_S} \delta \left[ |m_C^+ v^2|^i_{\parallel tr} + |m_C^+ v^2|^i_{\perp tr} \right] = - \sum_j^{N_R} \delta \left[ |m_C^+ v^2|^i_{\parallel tr} + |m_C^+ v^2|^i_{\perp tr} \right] \quad 6.10$$

or :

$$\sum_k^{N_S} \delta \left[ \alpha |m_C^+ v^2|^i + \beta |m_C^+ v^2|^i \right] = - \sum_j^{N_R} \delta \left[ \alpha |m_C^+ v^2|^i + \beta |m_C^+ v^2|^i \right] \quad 6.10a$$

or :

$$\sum_k^{N_S} \delta \left[ E_{EM}^i + E_G^i \right] = - \sum_j^{N_R} \delta \left[ E_{EM}^i + E_G^i \right] \quad 6.10b$$

This important result, taking into account (5.49), means that variations of kinetic energy of elementary particles of sender  $N_S$  should be compensated by the opposite (counterphase) variations of kinetic energy of receiver  $N_R$ , responsible for electromagnetism and gravitation

after synchronization of their key frequencies.

It leads from our approach, that the formation of Psi-channel between sender [S] and receiver [R] needs two interrelated process, representing the coarse and fine [S]  $\rightleftharpoons$  [R] tuning, correspondingly:

1) *the frequency synchronization* as a result of the neurodynamics processes in [S] and [R] 'tuning', resulting in  $[v_S \rightarrow v_R]$ , as a condition of (5.49 and 5.49a). This process may include a few stages:

- a) the synchronization of electroencephalogram, reflecting low frequency (8 - 10 Hz) brain rhythm of [S] and [R], enhanced by Schumann geophysical resonance with close frequency;
- b) synchronization of frequency of neuron ensembles firing with frequencies about 40 Hz;
- c) synchronizations of elementary acts of consciousness, described in previous chapter of this paper, including [gel-sol] transitions;

d) synchronization between  $[C \rightleftharpoons W]$  pulsation of elementary particles of [S] and [R], i.e. 'tuning' of their Virtual replicas  $(VR)^S$  and  $(VR)^R$ ;

2) *the counterphase correlation* of longitudinal and translational contributions to  $[C \rightleftharpoons W]_{\parallel, \perp}$  dynamics of particles, participating in elementary acts of perception and consciousness/subconsciousness, responsible for electromagnetic and gravitational potentials creation, reflected by (6.10-6.10b). This process is modulated by the next hierarchical levels of dynamics:

a) antiphase correlation of 'flickering' of water clusters (mBC) in microtubules, i.e. their [assembly  $\rightleftharpoons$  disassembly] with frequency of about  $10^7$  Hz;

b) counterphase correlation of the electrons, protons and anions collective dynamics in a course of transport across the neurons and axons membranes, accompanied their excitation/depolarization in [S] and [R] systems. *The corresponding oscillation of the huge gradient of electric tension in membranes (100.000  $\rightleftharpoons$  0) V/cm provides the conditions of alternating acceleration of charged particles inside and at vicinity of the membranes, necessary for bremsstrahlung, like in undulator and synchrotron radiation, discussed above (eqs. 5.53 - 5.57). The counterphase correlation of fundamental  $[C \rightleftharpoons W]_{\parallel, \perp}$  dynamics of [S] and [R] provides the conditions of formation of standing waves of three kinds: electromagnetic, gravitational and virtual pressure waves (VPW $^\pm$ ) of Bivacuum.*

The contribution to BvSO of low frequency ( $v \sim 10$  Hz) biomagnetic field, generated by correlated nerve excitations with wavelength about  $\lambda_{Bm} = c/v \sim 30\,000$  m or bigger, radiated by [S] and [R] in the case of telepathic contact, should be taken into account, as additional component of Psi field:

$$\sum^n [\mathbf{H}(\boldsymbol{\mu}_+ - \boldsymbol{\mu}_-)_n]_{x,y,z} = \sum^n [\mathbf{H}(2\boldsymbol{\mu}_B)_n]_{x,y,z} \quad 6.11$$

Formula (5.53a) can be transformed to more general form:

$$\sum_k^{N_S} \delta \left[ \alpha |m_C^+ v^2|^i + \beta |m_C^+ v^2|^i + \mathbf{H} 2\boldsymbol{\mu}_B^i \right]_{x,y,z} = - \sum_j^{N_R} \delta \left[ \alpha |m_C^+ v^2|^i + \beta |m_C^+ v^2|^i + \mathbf{H} 2\boldsymbol{\mu}_B^i \right]_{x,y,z} \quad 6.12$$

or :

$$\sum_k^{N_S} \delta \left[ \mathbf{E}_{EM}^i + \mathbf{E}_G^i + \mathbf{H} 2\boldsymbol{\mu}_B^i \right] = - \sum_j^{N_R} \delta \left[ \mathbf{E}_{EM}^i + \mathbf{E}_G^i + \mathbf{H} 2\boldsymbol{\mu}_B^i \right] \quad 6.12a$$

In secondary Bivacuum the deviation of ratio of mass-energy of the complementary ( $V^-$ ) and actual ( $V^+$ ) rotors and antirotors, forming BVF $^\dagger$  from  $\left[ \frac{m_C^- c^2}{m_C^+ c^2} \right]^{EM,G} = 1$ , pertinent for primordial

Bivacuum, is dependent on 'longitudinal' and 'transverse' translational *external* velocities of  $BVF^\dagger$ , as it follows from (5.20) like:

$$K_{V^+ \rightleftharpoons V^-}^{EM} = \left[ \frac{m_C^- c^2}{m_C^+ c^2} \right]^{EM} = 1 - \left( \frac{v_{\parallel tr}}{c} \right)^2 \quad 6.13$$

$$K_{V^+ \rightleftharpoons V^-}^G = \left[ \frac{m_C^- c^2}{m_C^+ c^2} \right]^G = 1 - \left( \frac{v_{\perp tr}}{c} \right)^2 \quad 6.13a$$

At the Golden mean conditions, corresponding to contributions of zero-point longitudinal and transversal vibrations oscillations of elementary particles (see 5.34b and 5.34c) to Bivacuum fermions ( $BVF^\dagger$ ) dynamics, we have in 6.13 and 6.13a:

$$\left( \frac{v_{\parallel tr}}{c} \right)_\phi^2 = \alpha\phi \quad \text{and} \quad \left( \frac{v_{\perp tr}}{c} \right)_\phi^2 = \beta\phi \quad 6.13b$$

The equilibrium constants of secondary Bivacuum, related to fields, generated by particles (5.56 and 5.57) have the reverse dependence with those, generated by antiparticles:

$$\tilde{K}_{V^+ \rightleftharpoons V^-}^{G,EM} = 1/K_{V^+ \rightleftharpoons V^-}^{G,EM} \quad 6.14$$

In addition to described above processes, the isotropically distributed cosmic and secondary atmospheric neutrino, propagating through each cell of sender [S] and receiver [R] from both sides, may participate in formation of Psi-field. In accordance to our approach, neutrino is a private case of BvSO, corresponding to Golden mean conditions (see section 5.5). This neutrinos can be modulated by scattering on the electrons and protons of the nerve cells membranes, changing their dynamics in a course of elementary acts of consciousness. Consequently, the modulated neutrino flux also may serve as a carrier of information exchange between [S] and [R].

The double membranes of coherent nerve cells may provide the cumulative Casimir effect and virtual particles creation, participating in generation of Virtual Replica of [S] and [R].

The frequencies of 3D virtual pressure waves ( $VPW^\pm$ ), forming  $VR^{S,R}$  of condensed matter of (S) and (R) are the result of following combinations, taking into account frequencies of molecular librations ( $\Omega_{lb}$ ) and translations ( $\Omega_{tr}$ ):

$$[\omega_{VPW^\pm}(S)] = [q\omega_{C \rightleftharpoons W} + r\Omega_{lb} + g\Omega_{tr}]_S \quad 6.15$$

$$[\omega_{VPW^\pm}(R)] = [q\omega_{C \rightleftharpoons W} + r\Omega_{lb} + g\Omega_{tr}]_R \quad 6.15a$$

$$p, q, g = 1, 2, 3, \dots (\text{integer numbers})$$

The anisotropic Harmonization force of Bivacuum:  $[F_{HaF}]_{1,2,3}$  have the same meanings, as in (5.49b).

The consequence of the overlapping of  $VR^S$  and  $VR^R$  on the atomic and molecular levels, affecting the probability of virtual particles/antiparticles origination - annihilation, could be the modulation **charge screening** effects in matter, which displays themselves in the spectral Lamb shift and changing the atomic and molecular polarization, leading in turn, to change of Van der Waals interactions in condensed matter. Another possible experimental approach to detect Bivacuum perturbation, related to Mind activity, is the precise measurement of Casimir effect (Lamoreaux, 1997; Mohideen and Roy, 1998), very sensitive to vacuum virtual pressure. The value and sign of Casimir effect is determined by difference between the external as respect to conducting surfaces and internal effective virtual pressure.

This kind of [S+R] interaction can be modulated by selected vibrations of molecules of [S]. It means possibility of modulation of Bivacuum permittivity ( $\epsilon_0$ ) and permeability  $[\mu_0 = (\epsilon_0 c^2)^{-1} = f(\Omega^R)]$  by (S), affecting all kinds of electromagnetic intra- and inter-molecular interactions in (R).

It is obvious that parameters of  $VR^S$  of Mind/Brain in form of multidimensional quantum

hologram ( $QH^S$ ), formed by superposition of  $VPW_{BV}^\pm$  of Bivacuum and those, generated by matter  $VPW_M^\pm$  is much more variable (for example, dependent on intention) than VR of regular condensed Matter. The parameters of  $VR^S$  are dependent of human will, meditation and are more adjustable for maximum effect of Mind-Matter interaction. However, the physical principles of Matter-Matter and Mind-Matter interaction, as well as of Mind-Mind interaction (telepathy) are the same - macroscopic quantum entanglement, based on Principle of least action in form, described above.

*Spatial stability of complex systems:* atoms, molecules and that of solids means that in these systems superposition of CVC, representing [W] states of uncompensated sub-elementary particles, as well as  $VPW^\pm$  of pairs  $[F_\uparrow^- \bowtie F_\uparrow^+]$  forms hologram - like 3D standing virtual waves superposition with location of nodes in the most probable positions of corpuscular phase of the nucleons, electrons, atoms and molecules in condensed matter. The binding of CVC by  $BVF^\dagger$  restore the [C] phase of particles in positions, close to the most probable ones. So, the coherent atoms/molecules thermal oscillation in composition of clusters, representing mesoscopic Bose condensate (Kaivarainen, 2001b,c), should be strictly correlated with coherent  $[C \rightleftharpoons W]$  pulsations of their elementary particles. The opposite statement also is correct. The  $[C \rightleftharpoons W]$  decoherence and spatial disorientation (depolarization) of elementary particles of atoms and molecules in condensed matter, induced, for example by external fields or laser beam, may have a feedback reaction with their random thermal fluctuations.

### 6.3. Possible mechanism of Bivacuum mediated Psi phenomena

In accordance to our Unified model (UM) *Virtual Replica (VR)* of any condensed matter, including living organism, is a result of superposition of standing virtual pressure waves ( $VPW_{BV}^\pm$ ) of Bivacuum with  $VPW_M^\pm$  of Matter, activated by  $[C \rightleftharpoons W]$  pulsation of symmetric pairs  $[F_\uparrow^- \bowtie F_\uparrow^+]$  of triplets  $\langle [F_\uparrow^- \bowtie F_\uparrow^+] + F_\uparrow^\pm \rangle$ , forming elementary particles, like electrons and quarks with frequency  $\omega_{C \rightleftharpoons W}^i = m_0^i c^2 / \hbar$ , where  $m_0^i$  is the rest mass of the electrons/positrons of three generation ( $i = e, \mu, \tau$ ) at Golden mean conditions (Kaivarainen, 2002).<sup>17</sup>

In turn,  $[C \rightleftharpoons W]$  pulsation of elementary particles can be modulated via combinational resonance by thermal oscillations of atoms and molecules of condensed matter due to in-phase relativist mass oscillation of particles. The bigger are coherent clusters of oscillating molecules with modulation frequency ( $\Omega \ll \omega_{C \rightleftharpoons W}$ ) and their kinetic energy, the bigger is modulation amplitude. As far the Bivacuum fundamental frequency of quantum transitions between its excited substates is close to  $\omega_{C \rightleftharpoons W}^i$ , it interacts with matter by resonance principle. As far Bivacuum has a properties of the active medium tending to self-organization, VR of matter may exist in form of virtual multidimensional autowave. Another way of VR modulation is oscillation of nonlocal Bivacuum symmetry (BvSO), induced by  $[C \rightleftharpoons W]$  pulsation of unpaired sub-elementary particles  $F_\uparrow^\pm$  of triplets.

We present a basically new physical approach to problem of Mind-Matter and Mind-Mind interaction, based on the exchange of Virtual Replicas (VR) of 'sender' [S] and 'receiver' [R]: ( $VR^S \rightleftharpoons VR^R$ ), using mechanism of *quantum teleportation* (Bouwmeester et al. 1997; Marcer, 2001). Each VR can be subdivided to the *internal-local* ( $VR^{in}$ ) and the two kinds of *external* ( $VR^{ext}$ ) contributions.

The *internal-local* contribution of  $VR^{in}$  represents all kinds of virtual 3D standing de Broglie waves ( $VC^{in}$ ) in the volume of condensed matter, corresponding to [W] phase of all particles of matter and virtual quanta, responsible for interactions, mediated by their exchange. This includes nuclear and intermolecular electromagnetic Van-der Waals interaction. The *external*  $VR^{ext}$  contribution has a properties of *quantum hologram*, containing two modulated by matter inseparable components: the *distant* ( $VR_{dis}^{ext}$ ) and *nonlocal* ( $VR_{nl}^{ext}$ ) one. It is supposed, that between external and internal virtual replicas strong interdependence is existing, providing feedback reaction, like ( $VR^{in} \rightleftharpoons VR^{ext}$ ).

The superposition/modulation of  $VPW_{BV}^\pm$  of Bivacuum by  $VPW_M^\pm$ , generated by elementary particles of matter ( $M$ ), results in formation of distant ( $VR_{dis}^{ext}$ ). The *primary* modulation of

$VPW_{Bv}^{\pm}$  by matter is a result of superposition of  $(VC^{\pm})_{Bv}$  of Bivacuum with virtual clouds  $(VC^{\pm})_M$ , emitted and absorbed in a course of  $[C \rightleftharpoons W]$  pulsation of symmetric pairs  $[\mathbf{F}_{\uparrow}^{-} \bowtie \mathbf{F}_{\uparrow}^{+}]$  of elementary particles of Matter.

In turn, the *secondary* modulation of pulsation frequency  $\omega_{C \rightleftharpoons W}$  and  $VPW_M^{\pm}$  occurs with frequency  $(\Omega_{tr,lb})$  of *coherent vibrations* (translations, librations) of atoms and molecules of matter. The unperturbed by matter Bivacuum  $VPW_{Bv}^{\pm}$  play the role of the pilot waves in formation of quantum hologram  $(VR_{dis}^{ext})$  of matter. The  $VR_{dis}^{ext}$  realize the *amplitude/frequency correlation* between  $[C \rightleftharpoons W]$  pulsation of particles of [S] and [R] in the quantum informational exchange.

For the other side, the *nonlocal vibro-gravitational component of Virtual Replica*  $VR_{nl}^{ext}$  of [S] and [R] is represented by *Bivacuum shift oscillation (BvSO) with tachyon properties*. The BvSO are excited as a result of the oscillation of Bivacuum dipoles oscillation, accompanied the coherent  $[C \rightleftharpoons W]$  pulsation of uncompensated sub-elementary particles  $\mathbf{F}_{\uparrow}^{\pm}$  of triplets  $\langle [\mathbf{F}_{\uparrow}^{-} \bowtie \mathbf{F}_{\uparrow}^{+}] + \mathbf{F}_{\uparrow}^{\pm} \rangle$  and also modulated by vibration of particles. The basic frequency of BvSO is the same, as that of  $VPW_M^{\pm}$ , equal to  $\omega_{C \rightleftharpoons W}$ . The modulation frequency of thermal molecular vibrations of matter, occurs with frequency of translations and librations  $(\Omega_{tr,lb})$ . This nonlocal component of virtual replica of matter  $(VR_{nl}^{ext})$  realize the *counter-phase correlation* of  $[C \rightleftharpoons W]$  pulsation of elementary particles of sender [S] and receiver [R] and secondary modulation of their  $VR^S$  and  $VR^R$  in the process of quantum entanglement described above.

Consequently,  $VR_{nl}^{ext}$  and  $VR_{dis}^{ext}$  are responsible, correspondingly, for the phase and amplitude/frequency signals transmission between [S] and [R] in the process of quantum teleportation. This would permit the virtual hologram's patterns exchange in the process of Matter-Matter, Mind-Matter and Mind-Mind (telepathy) interaction.

Each elementary particle, atom and molecule may have own characteristic virtual replica with properties of Quantum hologram. More active and stable  $VR^{in,ext}$  may be formed by coherent clusters of atoms/molecules in quantum state of mesoscopic Bose condensate [mBC] (Kaivarainen, 2000; 2001). The [mBC] may exist in proteins, DNA, membranes, water (especially in microtubules), chromosomes, bones and any other kind of condensed matter, as it shown in our Hierarchic theory of condensed matter.<sup>7</sup> The  $VR^{ext}$  of *complex systems* of Matter represents the hierarchy of  $VR^{ext}$  of their *subsystems*.

We may conclude, that the formation of  $[S \rightleftharpoons R]$  Psi-channel is a result of superposition of nonlocal Bivacuum symmetry oscillation  $(BvSO)^S \approx (BvSO)^R$ , generated by counterphase vibrations of particles of [S] and [R], participating in elementary acts of consciousness. The informational/energetic exchange between [S] and [R] is a result of modulation of 'tuned' dynamics modulation of  $VR^R$  of [R] by  $VR^S$  of [S] by change of their  $BvSO^{S,R}$ , generated by dynamics of groups of coherent particles, participating in elementary acts of perception and consciousness. The quantum neurodynamics processes in [S] may be accompanied by radiation of electromagnetic and vibro-gravitational waves. The former kind of radiation has been revealed experimentally.

For the other hand, we keep in mind that magnetic field may influence the dynamic equilibrium of Bivacuum fermions with opposite spins and magnetic moments  $[BVF^{\uparrow} \rightleftharpoons BVF^{\downarrow}]$ , related with Bivacuum symmetry shift.

Such additional equilibrium shift of Bivacuum in fact means superfluous energy of Bivacuum, transmitted from [S] to [R] in the process of Mind - Matter and Mind-Mind interaction.

The deviation of virtual replica (VR) from "Virtual Noise" of Bivacuum is dependent on the scale of coherent molecular/atomic excitations in the volume of matter, **which define the amplitude of VR**. The proximity of characteristic frequency of VR to fundamental Golden mean frequency of Bivacuum (fundamental BvO) determines the effectiveness of resonant matter-bivacuum energy exchange.

Influence of the *VR of sender (S) on VR of receiver (R)* is supposed to occur in such a way,

that it change polarizability of molecules of (R), their Van der Waals interactions and, consequently, probability of thermal fluctuations of molecules. In general case such influence is anisotropic, i.e. spatially asymmetric.

The change of molecular and atomic polarizability may be resulted from idea of Puthoff, Little, Ivison (2000), that the change of vacuum dielectric constant ( $\pm\Delta K$ ) could be accompanied by change of vacuum permittivity ( $\pm\Delta\epsilon_0$ ) and vacuum permeability ( $\pm\Delta\mu_0$ ). *Consequently, in accordance to our model, perturbation of  $VR^R$  under the influence of  $VR^S$ , mediated by nonlocal BvSO should be accompanied by change of Bivacuum dielectric permittivity ( $\epsilon_0$ ) and magnetic permeability ( $\mu_0$ ), interrelated with each other as:  $\epsilon_0 = 1/(\mu_0 c^2)$ .*

It leads from our UM, that the constant of dynamic equilibrium [ $BVF^\uparrow \rightleftharpoons BVF^\downarrow$ ] of secondary Bivacuum, related to gravitational ( $K_{BVF^\uparrow}^G$ ) and electromagnetic ( $K_{BVF^\uparrow}^{EM}$ ) potentials, may influence ( $\epsilon_0$ ) and ( $\mu_0$ ), as it influence on difference of virtual particles and virtual antiparticles creation. The possibility of exchange between (R) and (S) by  $VR^R$  and  $VR^S$ , means unification of S and R in one system. It could be considered as a macroscopic quantum entanglement.

The important role in Bivacuum mediated Mind-Matter and Mind-Mind interaction, plays the coherent fraction of water in **microtubules** of neurons in state of **mesoscopic molecular Bose condensate (mBC)** (Kaivarainen, 2000; 2001). This fraction of **mBC** is a variable parameter, dependent on structural state of microtubules and number of simultaneous elementary acts of consciousness (Kaivarainen, 2000, 2001). It can be modulated not only by excitation of nerve cells, but also by specific interaction with virtual replica of one or more chromosomes ( $VR^{DNA}$ ) of the same or other cells.

*The change of frequency of selected kind of thermal fluctuations, like cavitational ones, in the volume of receiver [R], including cytoplasm water of nerve cells, is accompanied by reversible disassembly of microtubules and actin' filaments, i.e. [gel  $\rightleftharpoons$  sol] transitions. These reactions, responsible for elementary act of consciousness (Kaivarainen, 2000; 2001), are dependent on the changes of corresponding activation barriers. These changes can be initiated by interaction of  $VR^R$  of [R] and  $VR^S$  of sender [S].*

*The mechanisms of macroscopic quantum entanglement, proposed in our work, is responsible for change of intermolecular Van der Waals interaction in the body of [R] and probability of selected thermal fluctuations (i.e. cavitational fluctuations), induced by [S]. In this case, realization of certain series of elementary acts of consciousness of [S] will induce similar series in nerve system of [R]. This means informational exchange between  $VR^R$  and  $VR^S$ , i.e. **telepathy**. The *individual character* of telepathic signal transmission from [S] to [R] may be provided by modulation of  $VR_{MT}^S$  of microtubules by  $VR_{DNA}^S$  of DNA of sender's chromosomes in neuron ensembles, responsible for acts of consciousness.*

### ***Explanation of genetic information exchange between distant cells and different organisms***

In accordance to our UM, all material objects, from elementary particle to planets and stars, including systems of all intermediate scales, like macromolecules, cells, organs, animals, etc. has very specific hierarchical virtual replicas, roughly subdivided to local and nonlocal. Some of VR are the carriers of information only and some of them can carry the momentum and energy.

The virtual replica ( $VR_{DNA}^{S,R}$ ) of highly ordered parts of the **eukaryote's** chromosomes (**introns**), not participating directly in biosynthesis and including more than 95% of total DNA, may play the active and very specific role in the [Mind-Matter] and [Mind-Mind] interaction. The so-called *nucleosomes* represent long parts of DNA, tuned around the histone octamer. The diameter of such nucleosomes (stable nuclear-protein complexes) is about 110 Å. The histones are able to modulate the DNA structure and functions. In accordance to our Hierarchic theory of condensed matter (Kaivarainen, 2000; 2001), the high density and stability of nucleosomes and native chromosomes provides condition for mesoscopic Bose condensation [mBC] at ambient temperature in their volume. The [mBC] may exist in form of so-called *primary translational and librational effectons*, representing 3D standing de Broglie waves of atoms/molecules of

condensed matter (chromosomes in private case).

The existence of [mBC] and their coherent  $[C \rightleftharpoons W]$  pulsation, allows the quantum entanglement between chromosomes and microtubules of distant cells and even between different organisms with similar properties of their molecular Virtual Replica (VR), as between [S] and [R].

It leads from our model, that the *synchronization of the interacting chromosomes dynamics by coherent photons of certain frequency and polarization*, should enhance the effect of quantum entanglement and interaction of their ( $VR^S$  and  $VR^R$ ), because of induced combinational resonance.

**Synchronization and spatial polarization** of modulated by BvSO  $[C \rightleftharpoons W]$  pulsation of elementary particles of chromosomes of *organisms-senders (S)* and *organisms - receivers (R)* can be provided by polarized electromagnetic waves with length, determined by dimensions of interacting organisms and distance between them, i.e. the order of meters for animals and human beings. These conditions points to radio-frequency of EM waves:  $(10^4 \div 10^8)$  1/s, generated by coherent fluctuations of density and dipole moment of DNA and microtubules, carrying such function.

*This consequence of our Unified model of Bivacuum and quantum entanglement between synchronized particles of certain spatial relative orientation can be considered, as a physical background for distant transmission of genetic information between cells (donors-senders) and cells (acceptors-receivers) of different organisms*, revealed by Dzang Kangeng (1992; 1993) and Gariaev's group (1994), activated by special optoelectronic equipment.

Dzang Kangeng (1992; 1993) used hexahedron, cone, sphere and a parabolic-reflector aerial, as a kind of forms, providing specific spinning (polarization) of the electromagnetic (EM) field. In the D. Kangeng's equipment the high-frequency generator of two orthogonally-polarized electromagnetic beams has been used, which repeatedly pass through the donor and the accepting biosystems, necessary for informational exchange between them. All known biopolymers are optically active, sometimes in very specific way. Consequently, polarization of photons should increase the effectiveness of interaction of chromosomes with coherent photons, dependent also on their frequency and density. It is obvious that *polarization modulation* of electromagnetic beam by sender [S] (donor), should influence the quantum and small-scale dynamics of DNA of receiver [R] (acceptor) and, consequently on its  $VR^R$ .

In Gariaev's version of Dzang Kangeng's device, the **polarized laser visible beam** ( $\lambda = 632$  nm) transforms to *coherently polarized radio waves* (PLRW) of frequency range:  $(10^3 - 10^6) s^{-1}$ . This effect is explainable in the framework of our Hierarchic theory of condensed matter (Kaivarainen, 2000; 2001), as a consequence of stimulated by laser photons transitions (fluctuations) of atoms in composition of nucleosomes, accompanied by so-called *convertions, macrodeformations and superdeformations, accompanied by EM-waves of (kHz - MHz) radio frequency* (Kaivarainen, 2000a). This device, like that of Dzang Kangeng, is shown to be able to transfer the genetic information between different organisms. This information may be related not only to gene-controlled biosynthesis, but also to *generation of still mysterious morphogenetic field*, responsible for spatial organization of the cells in organs and organs in organisms.

The spontaneous radiation of coherent 'biophotons' by DNA of wide frequency range has been revealed earlier by Gurvich (1977) and Popp (2000). Corresponding visible photons also may be converted in radio waves, as described above, even without external source of EM energy, like used in Gariaev's experiments.

*I put forward a conjecture, that the interaction between cells of the same eucaryotic organisms may be responsible for self-reparation/regeneration of the damaged cells. In this case two orthogonally-polarized electromagnetic beams may be radiated by microtubules of two orthogonal centrioles.* The frequency, intensity and polarization of these two beams could be modulated by VR and radiation of DNA of the same cells as microtubules. It is assumed, that radiation and VR of 'healthy' cells influence the structure of damaged DNA of other cells and activate corresponding enzymes, repairing due to such specific distant way the damaged DNA



structure and finally the cells function. The selected mutagenesis of DNA of receiver [R], induced by combination of all kind of Bivacuum excitation, generated by cells of sender [S], like virtual spin waves (VSW), Bivacuum symmetry oscillation (BvSO) and virtual pressure waves (VPW<sup>±</sup>) is possible also.

*The experimental facts, pointing to possibility of genetic information exchange between different cells of the same organisms and even different organisms by means of polarized EM waves, stimulating macroscopic quantum entanglement, may change our conventional paradigm of genetics and biological evolution drastically.*

#### 5.9. The examples of Psi - field interaction with physical fields, matter and remote biosystems

The following examples, collected by Savva [18] of how the Psi - field, generated by gifted 'Sender' [S] can interfere with other physical fields and biological and nonbiological targets.

- *Interference with weak (internuclear) forces:*

- speeding up and slowing down the rate of americium 241Am nuclear decay;

- *Interference with electromagnetic fields:*

- rotation of the plane of polarization of a polarized laser beam by 30° and 7°; - induction of a temporary peak in the Raman spectrum of tap water at 2200 cm<sup>-1</sup>; - temporary changes in the microstructure of water as observed through scattering of laser beam ( $\lambda = 632.8$  nm) at various angles; - deviation of the electrical resistance of a thermoresistor; - increase of adsorption and dispersion of a monochromatic laser radiation ( $\lambda = 10.6$  mm and 4 mm) by air, nitrogen and carbon dioxide; - deviation of UV adsorption spectra of DNA water solution in the area of 220-280 nm three independent observations; - induction of a periodic electrical signal from a piezoelectric sensor; - induction of a pulse magnetic field (100 nT and up to 27x106 nT), accompanied by rotation of a compasses needle;

- *Interference with gravitation field:*

- moving the plate of an encased precise analytical balance equivalent to 100 mg force;

- *Interference with performance of man-made devices:*

- predetermined deviation from randomness with high probability of various random number generators has been revealed in Princeton group; - increase of the concentration of dislocations (missing atoms in microcrystalline structure) in "metal bending" experiments with local increase of surface hardness.

These observations along with the well registered phenomena of remote viewing and precognition by Hal Puthoff and Russel Targ at Stanford Research Institute<sup>19</sup>, confirmed in other laboratories, are quite enough to believe, that different manifestations of Quantum Psi phenomena are really existing.

Fredericks and Bendorf revealed the unidentified tracks of developed silver in photographic emulsions, exposed for few minutes to human fingerprints even with dielectric isolator. Some features of these tracks and their strong dependence on magnetic field point to tachyon (superluminal) properties of track - induced particles.

*Water treated with a magnetic field has proven equal to, if not better than, intent-imprinted water at stimulating plant growth.* The IR absorption spectra of water, its surface tension and crystallization patterns are similar for both types of water treatment.<sup>20</sup>

The significantly higher (up to 105nT) magnetic signals during Qi emission from hands of qigong practitioners as compared to the controls were revealed (Lin & Chen, 2001).

Marcel Vogel<sup>21</sup> did pioneering research into the therapeutic applications of specially-cut quartz crystals and their effect on water. He claimed that these crystals could amplify the user's mental vibrations like a laser, creating a coherent field of energy that could act as a "carrier wave of information". He demonstrated that by circulating water around an intent-charged crystal he could generate measurable changes in the water, such as a decrease in surface tension, increased conductivity, a significant drop in the freezing point (as low as -30 degrees), bidirectional alterations in the pH up to 3 points, the appearance of two new bands in the IR and UV absorption spectrum, etc. Boiling of water after treatment shows no changes in the UV spectrum, so one can conclude that a permanent chemical change has taken place.

Douglas Dean and Edward Brame found that healer treated water demonstrated changes with both IR spectrophotometry (indicating altered hydrogen bonding) and specific peaks with UV spectrophotometry. The half-life for these effects lasted from tree days to as long as three years, in partially emptied bottles.

Among studies are those, that established interactions of gifted Psi field operators with enzymes and cells (including malignant cells) in vitro and in vivo, fungi/yeasts, bacteria, single-cell organisms, animals and humans. It is shown that the Psi-field as the carrier of the biological information cannot be significantly blocked by any physical screening, that the effect does not depend on the distance. It seems to be *non-isotropic, i.e. spatially directed*.

Lian Sidorov<sup>21,22</sup> has presented excellent review of data, pointing to biological/biochemical aspects of Psi -field action, including remote healing. There are two classes of distant healing: the target is found by the healer on the basis of a name, location, birth date, etc. (in remote viewing language, this would amount to a "coordinate"); and an adjunct (an object previously treated by the healer, such as water, cloth, a crystal, etc.) is used by the patient with or without the healer's knowledge.

In a 1991 Chien & al. report that they found the following biochemical effects when studying the influence of a qigong master's "facilitating" Psi-field on a culture of human fibroblasts: a 1.8% increase in cell growth rate in 24 hrs, 10-15% increase in DNA synthesis and 3-5% increase in cell protein synthesis in a 2 hr period. When the master emitted "inhibiting" Psi-field, the cell growth decreased by 6%, while DNA and protein synthesis decreased by 20-23%, respectively 35-48%. Chinese researchers have also shown that external Psi-field can increase blood plasma cAMP (Lin and Chen).

Intent-modulated emission of biophotons from the hands of qigong practitioners is a well-known phenomenon that has often been reported in the scientific literature. Eugene Wallace reported measuring up to 100 time stronger emissions from the hands of gifted persons compared to controls. A study by Nakamura & al.<sup>23</sup> reports an increase in subject's hand biophotons intensity associated with a drop in skin surface temperature during qigong practice.

Physical signal detectors have measured a variety of energy fluctuations in the vicinity of practitioners. In their review, Lin and Chen report 80% frequency modifications in the far infrared radiation detected 50 cm from the palm of a qigong practitioner.

*It was proposed by Beal and Oschman<sup>24</sup> that, under special conditions, resonant brainwaves may entrain the body's neural system to deliver healing frequencies to diseased tissues, or become coupled to the Schumann resonance and thus transmit distant healing effects to the target. But even accepting the Schumann resonance as a non-dissipative mechanism of information transmission, we are still faced with the enigma of mental interactions that cannot be attributed to EM fields - such as the effects on internuclear and gravitational forces described above.*

Numerous studies have demonstrated (Targ & Kutra, 1998) that size of the target (down to 1 mm square) and distance between sender [S] and target (up to 10,000 miles) do not appear to significantly impair signal perception. The electromagnetic shielding by Faraday cage or sea water does not negatively impact remote viewing ability. The fundamental quantum phenomena, related to vacuum - matter interaction, should be involved in these processes.

### Conclusion

*Our Unified Model (UM) suggests, that each kind of field, radiated by particle or system of coherent particles, is a consequence of corresponding kind of their uncompensated sub-elementary particles [ $F_{\ddagger}^{\ddagger} >$  dynamics: spin field (virtual spin waves in Bivacuum) are excited by spinning of  $CVC^{\cup}$  or  $CVC^{\cup}$  of [W] phase; the electromagnetic and gravitational fields are result of modulation of CVC by longitudinal and transversal components of momentum and kinetic energy of [ $F_{\ddagger}^{\ddagger} >$  as respect to direction of particle propagation.*

The specific magnetic component of Psi field of [S], responsible for targeting in Remote Vision (RV), Remote Healing (RH) and other Psi-phenomena is generated by the nerve impulse propagation along the axons, depolarization of nerve cells membranes in 'tuned' ensemble of

neuron cells. The nonlocal component of Psi-channel, determined by massless virtual spin waves, is most sensitive to variations of specific magnetic field, radiated by [S] in series of elementary acts of consciousness, perturbing in such a way the local Virtual Replica and quantum neurodynamics of [R]. The Psi-channel between [S] and [R] works better, if the frequency of geomagnetic Schumann waves have the same frequency (around 8 Hz), close to brain waves frequency, is the same in their location, providing better resonance conditions.

Modulation of Schumann waves by low frequency brain waves may participate in telepathic contacts on macroscopic (whole body) and mesoscopic (neurons). Modulation of neutrino flux between [S] and [R] by scattering on electrons and protons of nerve cells membranes is also possible. The Psi-channel between [S] and [R], formed by nonlocal Bivacuum symmetry oscillation (BvSO), corresponds to finest tuning in telepathic contact on level of coherent clusters of water in state of molecular Bose condensate in microtubules of nerve cells.

The VR can be subdivided to the internal local ( $VR^{in}$ ) and the external ( $VR^{ext}$ ) contributions. The *internal - local* contribution of  $VR^{in}$  represents all kinds of virtual 3D standing de Broglie waves ( $VC^{\pm}$ ) in the volume of condensed matter, corresponding to [W] phase of all particles of matter and interactions, mediated by virtual quanta exchange, i.e. from nuclear to intermolecular electromagnetic Van-der Waals interaction.

The overall shape of the total virtual replica is a superposition of virtual replicas of its elements is close to shape of the whole body and corresponds to notion of the "ether body (EB)" in Eastern philosophy:

$$EB \equiv VR_{tot}^{in} = \sum VR^{in}$$

The *external*  $VR^{ext}$  contribution has a properties of *quantum hologram*, containing **two modulated by matter** inseparable components:

1) the *distant* in forms of superposition of Virtual Pressure Waves ( $VPW^{+}$  and  $VPW^{-}$ ) of positive and negative vacuum ( $VR_{dis}^{ext}$ ), electromagnetic and gravitational contributions, reflected in longitudinal and transversal *Bivacuum symmetry oscillations (BvSO)*;

2) the *nonlocal* ( $VR_{nl}^{ext}$ ), related with virtual spin waves (VSW) and repulsion/attraction between BVF in Psi-channel, provided by Pauli principle.

The superposition of all kind of external virtual replicas may correspond to notion of the "astral body (AB)":

$$AB \equiv VR_{tot}^{ext} = \sum VR_{dis}^{ext} + \sum VR_{nl}^{ext}$$

The nonlocal and distant  $VR_{nl}^{ext}$  and  $VR_{dis}^{ext}$ , *modulated by Psi field*, are responsible for the *phase and amplitude* signals transmission between [S] and [R], correspondingly, in the process of quantum teleportation via Psi-channel. This would permit the virtual hologram's patterns exchange in the process of Mind-Matter (i.e. telekinesis and remote vision) and Mind-Mind (i.e. telepathy and remote healing) interaction. The mechanism of *quantum teleportation* has been discussed also by Bouwmeester et al. 1997 and Marcer, 2001.

The 1st stage of 'targeting' of Receiver [R] by Sender [S] in the process of remote vision or remote healing is superposition of their "astral bodies"; the 2nd stage is interaction between their "ether bodies", providing such phenomena as remote vision (RV), healing, telepathy, etc.

The concrete mechanism of telepathy and healing, as a private case of Mind-Matter interaction, is related to perturbation by Sender [S] the properties of Bivacuum in Psi channel in such a way, that Bivacuum permittivity and permeability is changed, depending on [S] intention. In turn, this influence on the strength of Van-der-Waals interaction increases or decreases the probability of thermal fluctuations, like cavitational ones, in body of [R], including cytoplasm of biocells and microtubules. In accordance to our theory of elementary act of consciousness, the modulation of [assembly=disassembly] of microtubules due to cavitational fluctuations in the nerve cells and corresponding [*gel*  $\rightleftharpoons$  *sol*] transitions by directed mental activity of [S] can provide *telepathic contact* between [S] and [R]. The mechanism of remote healing could be the

same, but the local targets in the body of patient [R] should be not necessarily the MTs of nerve cells, but MTs or other microfilaments (i.e. actin fibers) in cells of the ill organs, which also have their 'ether body' and can be targeted by healer.

Each elementary particle, atom and molecule may have own characteristic virtual replica with properties of Quantum hologram. The same is true for coherent clusters of atoms/molecules in quantum state of [mBC]. The [mBC] may exist in macromolecules, like proteins, DNA, membranes, water, chromosomes, bones and any other kind of condensed matter. The  $VR^{ext}$  of *complex systems* represents the hierarchy of  $VR^{ext}$  of their *subsystems*, *very sensitive to oscillation of Bivacuum symmetry shift with frequencies, close to resonant ones*.

The superposition of  $VPW_{Bv}^{\pm}$  of Bivacuum and  $VPW_M$ , generated by matter, forming ( $VR_{dis}^{ext}$ ), representing quantum hologram. Corresponding density energy and momentum oscillations of virtual clouds  $(VC^+)_{Bv}$  and anticlouds  $(VC^-)_{Bv}$  are the consequence of  $(VC^{\pm})_{Bv}$  creation and annihilation in a course of transitions between different sublevels of  $BvF^{\uparrow}$  and  $BvB^{\pm}$ , accompanied the propagation of  $VPW^{\pm}$  in Bivacuum. The *primary* modulation of  $VPW_{Bv}^{\pm}$  by matter is a result of superposition of  $(VC^{\pm})_{Bv}$  with virtual clouds  $(VC^{\pm})_M$ , emitted and absorbed in a course of  $[C \rightleftharpoons W]$  pulsation of symmetric pairs  $[F_{\uparrow}^- \bowtie F_{\downarrow}^+]$  of elementary particles of Matter with frequency, close to that of Golden mean:  $\omega_{C \rightleftharpoons W}^{\phi} = \omega_0 = m_0 c^2 / \hbar$ . For the regular electron the frequency of  $[C \rightleftharpoons W]$  pulsation is  $\omega_0^e \simeq 9 \cdot 10^{21} s^{-1}$ .

In turn, the *secondary* modulation of pulsation frequency  $\omega_{C \rightleftharpoons W}$  and  $VPW^{\pm}$  occur with frequency ( $\Omega$ ) of *coherent vibrations* (translations, librations) of atoms and molecules of matter, equal to frequency of  $BvSO$ , much lower, than  $VPW^{\pm}$ . The high frequency coherent  $VPW_{Bv}^{\pm}$  of Bivacuum play the role of the pilot waves in quantum hologram ( $VR_{dis}^{ext}$ ) of matter. *The modulated by matter virtual pressure waves  $VPW^+$  and  $VPW^-$ , propagating in Bivacuum with light velocity, are responsible for the 1st distant component of ( $VR_{dis}^{ext}$ ) of [S] and [R]*.

The uncompensated difference between energy density of positive and negative virtual pressure waves:  $\Delta \varepsilon_{VPW^{\pm}} = \varepsilon_{VPW^+} - \varepsilon_{VPW^-}$  and corresponding excessive Harmonization force ( $\Delta F_{HaF}$ ) of Bivacuum realize the *amplitude/frequency correlation* between  $[C \rightleftharpoons W]$  pulsation of particles of [S] and [R] in the luminal quantum energy/informational exchange by means of  $VR_{dis}^{ext}$ .

*The nonlocal vibro-gravitational 2nd component of Virtual Replica ( $VR_{nl}^{ext}$ ) of [S] and [R] is represented by  $BvSO$  with tachyon properties*. The  $BvSO$  are excited by the coherent  $[C \rightleftharpoons W]$  pulsation of uncompensated sub-elementary particles  $F_{\uparrow}^{\pm}$  of triplets  $\langle [F_{\uparrow}^- \bowtie F_{\downarrow}^+] + F_{\uparrow}^{\pm} \rangle$ . The frequency of  $BvSO$  is equal to frequency of the thermal molecular dynamics of matter ( $\Omega \sim 10^{12} Hz$ ). The amplitude of  $BvSO$  is determined by number of coherent molecules/atoms in composition of Sender [S], i.e. on degree of mesoscopic molecular Bose Condensation (mBC) (Kaivarainen, 2000; 2001) in [S]. This nonlocal component of virtual replica of matter ( $VR_{nl}^{ext}$ ) realize the *phase correlation* of  $[C \rightleftharpoons W]$  pulsation of elementary particles of sender [S] and receiver [R] in their quantum entanglement. Combination of both component — luminal  $VR_{dis}^{ext}$  and nonlocal  $VR_{nl}^{ext}$  provides quantum teleportation between [S] and [R].

This macroscopic entanglement is responsible also for 'targeting' in  $[S] \rightarrow [R]$  interaction, using the principle of Least action and excessive Harmonization force ( $\Delta F_{HaF}$ ). This first stage of Psi- channel formation represents *counterphase* superposition of  $BvSO_S$  of [S] and  $BvSO_R$  of [R] (i.e. nonlocal standing wave:  $[BvSO_S \rightleftharpoons BvSO_R]$ ). It is a consequence of Principle of least action realization. This Psi- channel between [S] and [R] provide also the feedback reaction.

The effective contribution to  $BvSO_S$  in telepathic contacts can be generated by special kind of coherent molecular dynamics, related to mesoscopic Bose condensation (mBC) of water in microtubules of 'tuned' nerve cells ensembles and change of this [water+MT] dynamics. The collective [gel-sol] transitions in neurons bodies is accompanied by coherent [assembly - disassembly] of microtubules and actin filaments, as a result of nerve excitation. Such complex quantum neurodynamics process, followed by membranes channels conductivity change and synaptic reorganization, occurs with average frequency of about 40 Hz. We define this process as elementary act of consciousness, which may be imprinted in complex virtual replica (VR) of human and animals.

Consequently, telepathy we explain as a result of Bivacuum mediated superposition of distant and nonlocal components of external virtual replicas ( $VR_{dis}^{ext}$  and  $VR_{nl}^{ext}$ ) of  $[S]$  and  $[R]$ , affecting adequately their internal virtual replicas ( $VR_{S,R}^{in}$ ) and, consequently, their elementary acts of consciousness.

We introduce the notion of nonlocal Global Virtual Replica (GVR), as superposition of all material replicas of the Universe, including living organisms. The especially gifted persons, using their own VR, are able to perform the selective 'search' of GVR.

The possible subtle influence of human's cumulative VR in some special states on the Global VR (GVR) in bifurcation points of GVR self-organization, means possibility of the active role of human's consciousness in evolution of the Universe. *The possibility of GVR to self-organization is a consequence of nonequilibrium active medium of Bivacuum, composed from double cells - dipoles, the active elements.* Unification of the evolution of humans and animals consciousness (including their brains and bodies) with evolution of Bivacuum, as interrelated sub-systems of the Universe, is in accordance with ideas of von Neumann (1932) and Stapp (2001).

## REFERENCES

1. A. Kaiväräinen, J.Mol.Liq. 41, 53 (1989).
2. A. Kaivarainen, Book: Hierarchic concept of matter and field. Water, biosystems and elementary particles. New York, NY, pp. 482, ISBN 0-9642557-0-7 (1995).
3. A. Kaivarainen, Archives of Los-Alamos: <http://arXiv.org/abs/physics/0102086> (2001).
4. Eisenberg D., Kauzmann W., The structure and properties of water. Oxford University Press, Oxford, (1969).
5. A. Kaivarainen, Solvent-dependent flexibility of proteins and principles of their function. D.Reidel Publ.Co., Dordrecht, Boston, Lancaster, (1985).
6. A. Kaivarainen, Archives of Los-Alamos: <http://arXiv.org/abs/physics/0105067> (2000).
7. A. Kaivarainen. American Institute of Physics Conference Proceedings, **573**, 181 (2001).
8. Clegg J.S. and Drost-Hansen W. On the biochemistry and cell physiology of water. In: Hochachka and Mommsen (eds.). Biochemistry and molecular biology of fishes. Elsevier Science Publ. **1**, Ch.1, 1 (1991).
9. Dicke R.H. Coherence in spontaneous radiation processes. Phys.Rev. **93**, 99 (1954).
10. A. Kaivarainen, Archives of Los-Alamos: <http://arXiv.org/abs/physics/0003045> (2000).
11. A. Kaivarainen, CASYS: International Journal of Computing Anticipatory Systems. **10**, 322 (2001).
12. Hameroff S. Proceedings of 2nd Annual advanced water science symposium. Dallas, Texas, USA (1996).
13. Hameroff S.R. and Penrose R. In: Toward a Science of Consciousness - Tucson I, S. Hameroff, a. Kaszniak and A.Scott (eds.). MIT Press, Cambridge, MA. 507 (1996).
14. Singer W. Annu. rev. Physiol., 55, 349 (1993).
15. Albrecht-Buehler G. J.Cell Biol. , **114**, 493 (1991).
16. Albrecht-Buehler G. Rudimentary form of cellular "vision". Proc. Natl. Acad. Sci. USA, **89**, 8288 (1992).
17. A. Kaivarainen, CASYS: International Journal of Computing Anticipatory Systems. **10**, 121 (2001); Archives of Los-Alamos <http://arXiv.org/abs/physics/0207027> (2002).
18. S. Savva MISAHA Issue 24-27, February (2000).
19. Puthoff, Harold and Russel Targ. Direct Perception of Remote Geographical Locations. In The Iceland Papers, A. Puharich, Editor, 1979. Republished by The Planetary Association for Clean Energy, Ottawa, Canada, 17 (1996).

20. Benor, D. *Healing Research*, Vol.1, Helix, UK, 366 (1992).
21. Sidorov, L. (2001) On the Possible Mechanism of Intent in Paranormal Phenomena. *Journal of Theoretics*, July (2001); (URL [www.journaloftheoretics.com/Links/links-papers.htm](http://www.journaloftheoretics.com/Links/links-papers.htm) );  
JNLRMI 1 (1) January 2002 (URL [www.emergentmind.org/sidorov\\_I.htm](http://www.emergentmind.org/sidorov_I.htm) )
22. Sidorov, L. (2002) The Imprinting and Transmission of Mentally-Directed Bioinformation. *JNLRMI* 1(1) January 2002; (URL: [www.emergentmind.org/sidorov\\_II.htm](http://www.emergentmind.org/sidorov_II.htm) )
23. Nakamura, H., Kokubo, H., Parkhomtchouk, D., Chen, W., Tanaka, M., Zhang, T., Kokado, T., Yamamoto, M. and Fukuda, N. Biophoton and temperature changes of human hand during Qigong. *Journal of ISLIS* 18(2) September (2000).
24. Oschman, J.L. The Electromagnetic Environment: Implications for Bodywork. Part I: Environmental Energies. *Journal of Bodywork and Movement Therapies* 4 (1) 56 January (2000).